

SAMSUNG

SAMSUNG DIGIT*all*
everyone's invited™

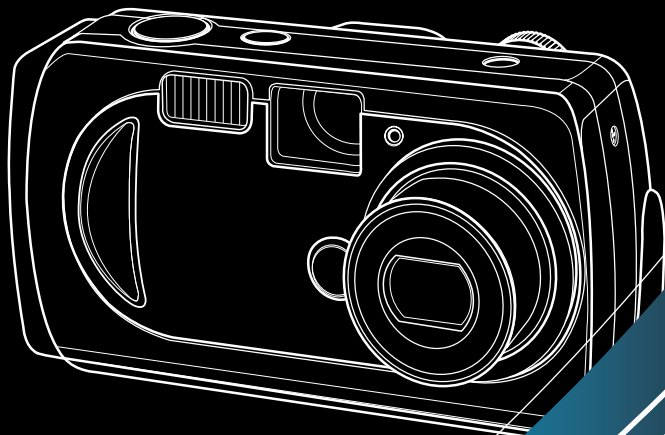

ENGLISH

SAMSUNG CAMERA

User's Manual

Digimax 250

Thank you for buying a Samsung Camera.

This manual will guide you through using the camera, including capturing images, downloading images and using the application software. Please read this manual carefully before using your new camera.

Instructions

- Use this camera in the following order

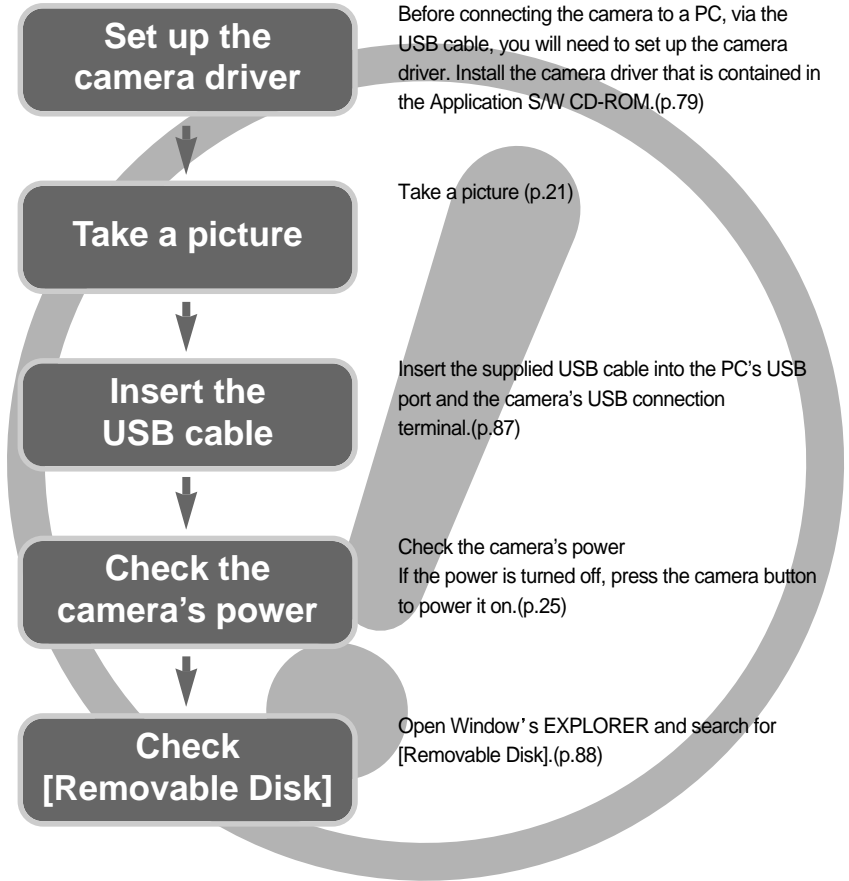

- To play back a video shot with this camera, be sure to use the QuickTime player supplied on the software CD-ROM. Applications that do not support the MPEG-4 codec (e.g., Windows Media Player) may not be able to play back the video.
- If you use a card reader to copy the images on the memory card to your PC, there is a small risk that the images could be damaged. When transferring the images taken with the camera to your PC, be sure to use the supplied USB cable to connect the camera to your PC. Please note that the manufacturer holds no responsibility for loss or damage of images on the memory card due to the use of a card reader.

Contents

READY

● Getting to know your camera	5
● About the icons	5
● Danger	6
● Warning	6
● Caution	7
● An FCC warning	7
● This digital camera can be used for	8
● Manufacturer's contents	10
● Identification of features	11
■ Front & Top	11
■ Back & Bottom	11
■ Side/ 5-function button	12
■ Mode dial	12
● Connecting to a Power Source	15
■ Using the AC power adapter (SAC-32)	15
■ Using the batteries	16
● Instructions on how to use the memory card	17
■ Maintenance of the memory card	17
■ Preserving the memory card data	17
● Inserting the memory card	19
● Removing the memory card	19

RECORDING

● LCD monitor indicator	20
● Starting the recording mode	21
● Using the camera buttons to adjust the camera	25
■ POWER button	25
■ SHUTTER button	25

● WIDE / TELE button	25
● Voice memo / UP button	27
■ Recording a voice memo	27
● Macro/Down button (Focusing)	28
● Focus lock	29
● FLASH/ LEFT button	29
● Self-timer/ Right button	31
● MENU/ OK button	32
● +/- button	33
● LCD button	34
● Using the LCD monitor to adjust the camera settings	35
● How to use the menu	36
● Size	37
● Quality	37
● Metering	38
● Shooting	39
● Sharpness	41
● Effect	41
● White balance	42
● Photo Frame	43

PLAY

● Starting play mode	44
■ Playing back a still image	44
■ Playing back a movie clip	45
■ Playing back a recorded voice	45
● LCD monitor indicator	46
● Using the camera buttons to adjust the camera	47
■ Thumbnail/ Enlargement button	47
● Voice memo / Up button	48

Contents

● Play & Pause/Down button	49	● Important notes	70
● LEFT / RIGHT / MENU / OK button	50	● Warning indicator	72
● LCD button	50	● Before contacting a service center	73
● Delete button	51	● Specifications	75
● Setting up the play back function using the LCD monitor	52		
● Deleting all images	53		
● Protecting images	54		
● Starting the slide show	55		
● Resizing	56		
● Rotating an image	57		
● Copying	58		
● DPOF : Setting the Number of Copies to Print	59		
● DPOF : INDEX	60		
● DPOF : CANCEL	60		

SETUP

● Setup menu	61	● Software Notes	77
● File name	62	● System Requirements	77
● Auto power off	63	● About the software	78
● Language	64	● Setting up the application software	79
● Formatting a memory card	64	● Starting PC Mode	87
● Setting up the Date/ Time/ Date type	65	● Removing the USB Driver for Windows 98SE	90
● Imprinting the recording date	65	● Removable Disk	91
● Beep	66	● Removing the removable disk	92
● LCD brightness	66	● Setting up the USB Driver for MAC	93
● Selecting Video out type	67	● Using the USB Driver for MAC	93
● Quick view	68	● Using PhotoImpression	94
● Initialization(RESET ALL)	68	● Digimax Viewer 2.1	96
● Latest	69	● FAQ	97
● Start image	69		

SOFTWARE

Getting to know your camera

Thank you for buying a Samsung Digital Camera.

- Prior to using this camera, please read the user manual thoroughly.
 - When you require After Sales service, please bring the camera and the cause of the camera malfunction (such as Batteries, Memory card etc.) to the A/S center.
 - Please check that the camera is operating properly prior to when you intend to use it (e.g. for a trip or an important event) to avoid disappointment. Samsung camera takes no responsibility for any loss or damages that may result from camera malfunction.
 - Keep the manual in a safe place.
- ※ Microsoft, Windows and Windows logo are registered trademarks of Microsoft Corporation incorporated in the United States and/or other countries.
- ※ Apple, Mac and QuickTime logo are registered trademarks of Apple computer.
- ※ All brand and product names appearing in this manual are registered trademarks of their respective companies.

About the icons

This manual contains instructions on using this camera that will help you to use this camera safely and correctly. This will help prevent danger and injury to others.



DANGER

DANGER indicates an imminently hazardous situation which, if not avoided, will result in death or serious injury.



WARNING

WARNING indicates a potentially hazardous situation, which, if not avoided, could result in death or serious injury.



CAUTION

CAUTION indicates a potentially hazardous situation, which, if not avoided, may result in a minor or moderate injury.

Danger

- Do not attempt to modify this camera in any way. This may result in fire, injury, electric shock or severe damage to you or your camera. Internal inspection, maintenance and repairs should be carried out by your dealer or Samsung Camera Service Center.
- Please do not use this product in close proximity to flammable or explosive gases, as this could increase the risk of explosion.
- Should any form of liquid or a foreign object enter the camera, do not use it. Switch off the camera, and then disconnect the power source (batteries or AC Power Adapter). You must contact your dealer or Samsung Camera Service Center. Do not continue to use the camera as this may cause a fire or electric shock.
- Do not insert or drop metallic or inflammable foreign objects into the camera through access points e.g. the memory card slot and battery chamber. This may cause a fire or electric shock.
- Do not operate this camera with wet hands. This could pose a risk of electric shock.

DANGER

Warning

- Do not use the flash in close proximity to people or animals. Positioning the flash too close to your subject's eyes, may cause eyesight damage.
- When taking photographs, never point the lens of the camera directly into very strong light. This may result in permanent damage to your eyesight.
- For safety reasons keep this product and accessories out of reach of children or animals to prevent accidents e.g.:
 - Swallowing batteries or small camera accessories. If an accident should occur, please consult a doctor immediately.
 - There is the possibility of injury from the camera's moving parts.
- Batteries and camera may become hot during prolonged use and it may result in camera malfunction. Should this be the case, allow the camera to sit idle for a few minutes to allow it time to cool.
- Do not recharge non rechargeable batteries. This may cause an explosion.
- Do not leave this camera in places subject to extremely high temperatures, such as a sealed vehicle, direct sunlight or other places of extreme variances in temperature. Exposure to extreme temperatures may adversely affect the camera's internal components and could cause a fire.
- When in use, do not cover the camera or AC Power Adapter. This may cause heat to build up and distort the camera body or cause a fire. Always use the camera and its accessories in a well-ventilated area.

Caution

- Leaking, overheating, or burst batteries could result in fire or injury.
 - Use batteries with the correct specification for the camera.
 - Do not short circuit, heat or dispose of batteries in fire.
 - Do not insert the batteries with the reverse polarities.
- Remove the batteries when not planning to use the camera for a long period of time. Batteries may leak corrosive electrolyte and irreparably damage the camera's components.
- Do not fire the flash while it is in contact with hands or objects. Do not touch the flash after using it continuously. It may cause burns.
- Do not move the camera while it is switched on, if you are using the AC Power Adapter. After use, always switch off the camera before unplugging the adapter from the wall socket. Then make sure that any connector cords or cables to other devices are disconnected before moving the camera. Failure to do so may damage the cords or cables and cause a fire or electric shock.

CAUTION

An FCC warning

• This device has been tested in accordance with the limits of a class B digital device under item 15 of the FCC rules. These limits are designed to provide protection against harmful interference in commercial installation. This equipment generates, absorbs and can emit radio frequency energy. If it is not installed and used in accordance with the instructions, it may cause harmful interference to radio communication. There is however, no guarantee that interference will not occur in some situations. Should any interference occur when this device is in operation, please try one or more of the following measures.

- Change the location and direction of any aerial.
- Increase distance between the camera and the affected device.
- Use a different socket away from the affected device.
- Please contact a Samsung agent or a radio/TV engineer.

• This device complies with part 15 of the FCC Rules.
• Changes or modifications not expressly approved by the party responsible for compliance could void user's authority to operate the equipment.

This digital camera can be used for

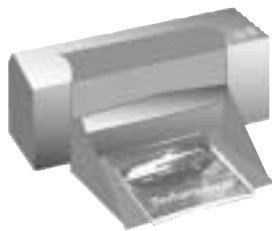

Printing images using a dedicated printer, DPOF-compatible printer or DPOF-equipped photo lab.
(refer to page 59)



Viewing images on a TV.
(refer to page 67)



Downloading image files from camera to computer.
(refer to page 88)



Taking a picture.
(refer to page 21)



Editing images on a PC.
(refer to page 94)

This digital camera can be used for

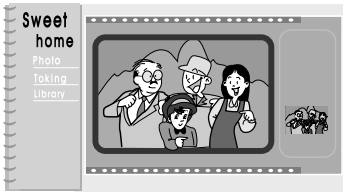

Creation of a digital photo album.

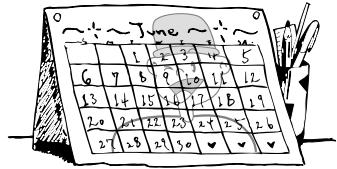

Taking a favourite image and creating your own personalized calendar with it.



Recording your voice.
(refer to page 22)



Recording a movie clip
(refer to page 23)



You can even create your own unique gift wrap paper by using your digital images.



Inserting images directly into any electronic document.

Manufacturer's contents

Please check that you have the correct contents before using this product.

 marked contents are optional.

Digital Camera



2 AA Alkaline Batteries



Pouch



VIDEO cable



USB cable



Camera strap



User manual



Product warranty



Software CD

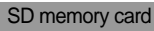

 SD memory card

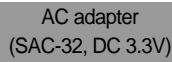

 AC adapter
(SAC-32, DC 3.3V)



Digimax Battery I-Pack : SBP-1303 KIT

Battery charger

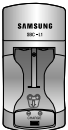

Rechargeable battery



AC cord



Identification of features

Front & Top

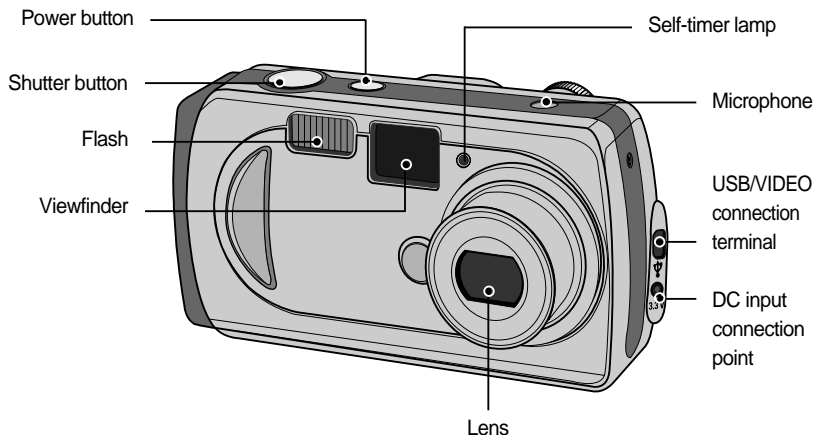

Back & Bottom

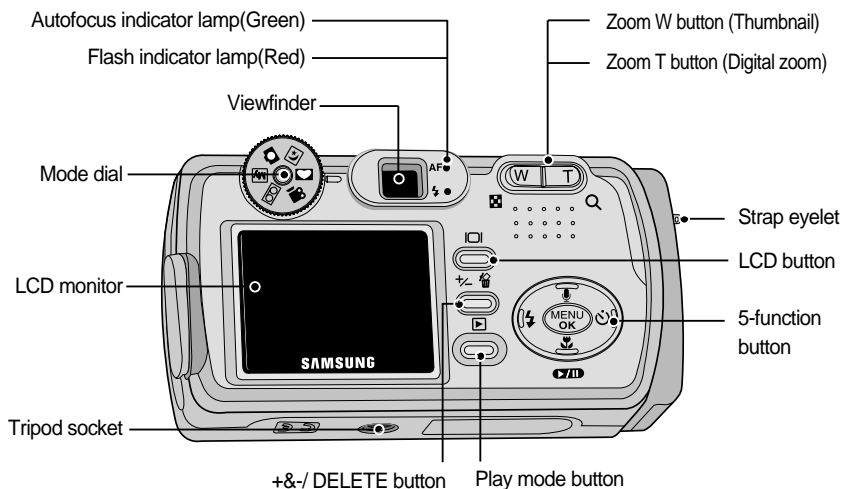

* When using the digital zoom to take a picture, the composition of the picture may be different depending on whether you are using the LCD monitor or the viewfinder. The picture will be taken in the composition of the picture as it appears on the LCD monitor.

Identification of features

Side/ 5-function button

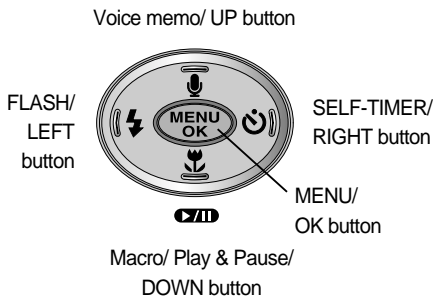
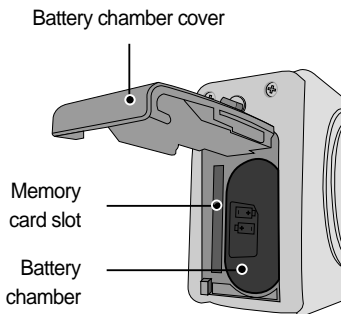

Mode dial

- You can select the desired working mode by using the mode dial located on the back of the camera. This digital camera has 6 recording modes. These are listed below.

- Still image mode

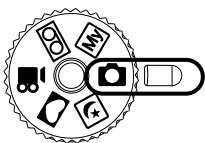

This mode allows you to take still images.

- Still image file format: *.jpg

- Shooting Range

- Macro mode (📷) : Wide : 0.15m ~ 0.8m
Tele : 0.6m ~ 0.8m
- Normal mode : 0.8m ~ infinity

- MySET mode

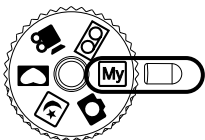

This mode allows users to save frequently used shooting settings for later use.

Identification of features

● Voice recording mode

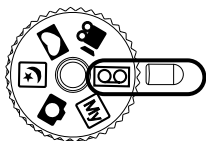

A voice recording can be recorded for as long as the available recording time of the memory capacity allows.(Max : 1 hour)
Voice recording file format: *.wav

● Movie clip mode

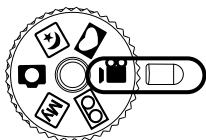

A movie clip can be recorded for as long as the available recording time of the memory capacity allows.

Image size : 320X240

Movie clip file type : *.mov

● Photo Frame mode

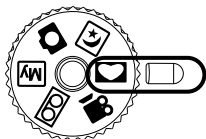

This mode allows users to add frame-like borders to a still image and save it. 9 types of frames are available.

● Night scene mode

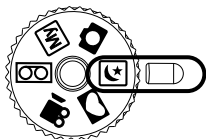

This mode is ideal for night photography, or when the subject is being shot against a dark background.

● The meaning of the camera operation mode icons used in this manual are as follows:

Icon	Mode dial	Camera working mode	Icon	Mode dial	Camera working mode
		Still image mode			MySET mode
		Voice recording mode			Movie clip mode
		Photo Frame mode			Night scene mode

	Play mode
--	-----------

Identification of features

■ Camera status lamp

Color	Status	Camera Status
Autofocus indicator lamp (Green)	Blinking and off	Power on processing
	On	When the LCD monitor is turned off When the USB cable is connected When the camera is in focus
	Blinking fast	While saving an image While transferring data between the camera and a PC When the camera is out of focus
Flash indicator lamp (Red)	Blinking slowly	While the flash is charging
	On	Flash is ready (when the SHUTTER button is pressed halfway)
Self-timer lamp (Red)	Blinking	- For the first seven seconds, the LED blinks at 1-second intervals. - For the final three seconds, the LED blinks quickly at 0.5-second intervals.
	Blinking once	When the camera's power is on / when the shutter button is released.

■ Beep

Beep sound	Camera condition
Power beep	When the camera power is turned on/off.
Normal beep (a short beep)	Rotating the mode dial/ pressing the camera buttons
Error beep (long beep twice and short beep twice)	When an error occurs
Self-timer beep	Beeps simultaneously with the Self-timer lamp blinking.

- To hear the beep sound, you have to set the beep sound to on in the setup mode menu.

Connecting to a Power Source

- There are two ways in which to provide the camera with power. You can use batteries or alternatively, you can use an AC(100 ~ 250V) Adapter (DC 3.3V 2.0A).
- We recommend using batteries for a digital camera.(Within a year from the date of manufacture) The batteries are listed below.
 - Non rechargeable batteries : AA type – Alkaline, Ni-Mn, Ni-Zn, Lithium
CR-V3 type – Lithium
 - Rechargeable batteries : AA type – Ni-MH, Ni-Cd (over 1000mA)
CR-V3 type – Digimax Battery I-Pack(SBP-1303)

INFORMATION

Important information about battery usage

- It is easy to buy alkaline batteries. However, the duration for using batteries varies in accordance with the battery manufacturer or the photographic conditions.
- When the camera is not used, turn off the camera power.
- Do not recharge the non rechargeable batteries. It may cause an explosion.
- Please remove the batteries if the camera will not be used for long periods. Batteries can lose power over time and are prone to leaking if kept inside the camera.
- We recommend high capacity ALKALINE batteries as manganese batteries cannot deliver sufficient power.
- Low temperatures (below 0 °C) can affect the performance of the batteries and you may experience reduced battery life.
- Batteries will usually recover at normal temperatures.
- Do not use old and new batteries at the same time.
- During extended use of the camera, the camera body may become warm. This is perfectly normal.

Using the AC power adapter (SAC-32)



If you have access to a mains supply, using an AC Adapter (3.3V 2.0A) allows the camera to be used for long periods of time. Plug the adapter into the connection point (DC IN 3.3V) on the camera. Remove the batteries from the camera when using an AC adapter.

Connecting to a Power Source

DANGER

- Always turn off the power before taking the AC adapter out of the mains supply.
- As with all mains powered devices, safety is important. Ensure that neither the camera nor adapter comes into contact with water or metallic materials.
- Please ensure that you use an AC adapter (3.3V 2.0A) with the correct specification for the camera. Failure to do so may affect your warranty.

Using the batteries

: If the camera does not turn on after you have inserted batteries, please check whether the batteries are inserted with the correct polarity(+ and-).

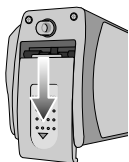

1. Open the battery chamber cover by pushing in the direction of the arrow.

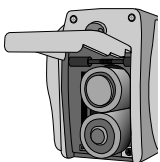

[Inserting the AA type battery]

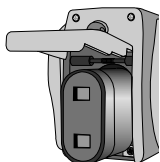

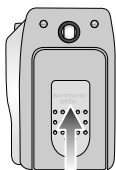

[Inserting the CR-V3 type battery]

2. Insert the batteries taking note of the polarity (+ /-).



3. To close the battery chamber cover, push it until it clicks.

- There are 3 indicators for battery condition that are displayed on the LCD monitor.

Battery indicator			
Battery status	The batteries are fully charged.	Prepare new batteries.	There is no battery capacity. Replace with new batteries.

Instructions on how to use the memory card

- The camera comes with 6MB of internal flash memory, allowing you to store images and movie clips in the camera. However, you can expand the memory capacity by using an optional memory card so that you can store more images and movie clips.

Maintenance of the memory card

- Be sure to format the memory card (see p. 64) if you are using a newly purchased memory for the first time, if it contains data that the camera cannot recognize, or if it contains images captured with a different camera.
- Turn off the camera power whenever the memory card is being inserted or removed.
- Repeated use of the memory card will eventually reduce the memory card's performance. Should this be the case, you will need to purchase a new memory card. Wear and tear on the memory card is not covered by the Samsung warranty.
- The memory card is an electronic precision device. Do not bend, drop or subject the memory card to any heavy impact.
- Do not store the memory card in an environment with strong electronic or magnetic fields, e.g. near loud speakers or TV receivers.
- Please do not use or store in an environment where there are extremes in temperature.
- Do not allow the memory card to become dirty or to come into contact with any liquid. Should this happen, clean the memory card with a soft cloth.
- Please keep the memory card in its case when not in use.
- During and after periods of extended use, you may notice that the memory card is warm. This is perfectly normal.
- Do not use a memory card that is used in another digital camera or memory card reader.
- Do not use a memory card formatted by another digital camera or memory card reader.

Preserving the memory card data

- If the memory card is subjected to any of the following, the recorded data may become corrupted :
 - When the memory card is used incorrectly.
 - If the power is switched off or the memory card is removed while recording, deleting (formatting) or reading.
- Samsung cannot be held responsible for lost data.
- It is advisable to copy important data onto other media as back-up e.g. floppy disks, hard disks, CD etc.
- If there is insufficient memory available :If you press the shutter button for the shot, a [CARD FULL !] message will appear and the camera will not operate. To optimize the amount of memory in the camera, replace the memory card or delete unnecessary images stored on the memory.

Instructions on how to use the memory card

INFORMATION

- Don't remove the memory card when the autofocus indicator lamp (Green) is blinking as this may cause damage to data in the memory card.

- You can use an SD memory card and MMC(Multi Media Card).

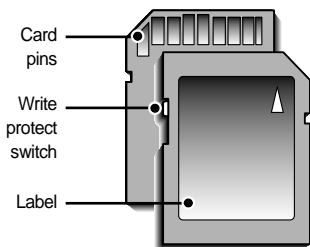

【SD(Secure Digital) memory card】

The SD memory card has a write protect switch that prevents image files from being deleted or formatted.

By sliding the switch to the bottom of the SD memory card, the data will be protected. By sliding the switch to the top of the SD memory card, the data protection will be canceled. Slide the switch to the top of the SD memory card before taking a picture.

- When using a 6MB internal memory, the specified shooting capacity will be as follows. (These figures are intended as an indication of expected performance). These figures are approximate as image capacities can be affected by variables such as subject matter.

Recorded image size	Super fine	Fine	Normal
1600X1200(1600)	6	10	16
1024X768(1024)	15	26	40
800X600(800)	25	43	64
640X480(640)	40	64	92

Inserting the memory card

1. Turn off the camera's power and push the Battery chamber cover in the direction of the arrow to open.



2. Have the card pins face toward the front of the camera (lens) and the label toward the back of the camera (LCD monitor), and then push the memory card into the card slot until you hear a "click".

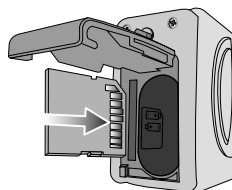

3. To close, push the battery chamber cover until you hear a click. If the memory card does not slide in smoothly, do not attempt to insert it by force. Check the direction of insertion, and then insert it correctly.

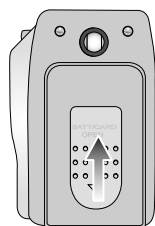

INFORMATION

- Do not insert the memory card the wrong way round . Doing so may damage the memory card slot.

Removing the memory card

1. Turn the power off using the power button.
Open the battery chamber cover and press the memory card as shown in the image and release.

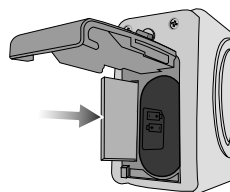

2. Remove the memory card and close the battery chamber cover.

LCD monitor indicator

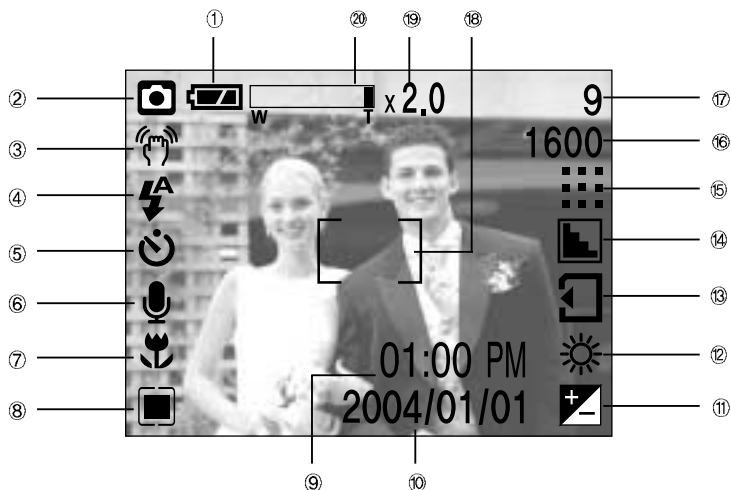

■ The LCD monitor displays information about the shooting functions and selections.



[Image & Full Status]

No.	Description	Icons	Page
1	Battery		p.16
2	Recording mode		p.12-13
3	Camera shake warning		p.24
4	Flash		p.30
5	Self-timer		p.31
6	Voice memo		p.27
7	Macro		p.28
8	Metering		p.38-39
9	Time	01:00 PM	p.65
10	Date	2004/01/01	p.65
11	Exposure compensation	-2.0 ~ 0 ~ +2.0 EV	p.33
12	White Balance		p.42
13	Card Inserted indicator		p.19

LCD monitor indicator

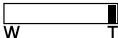
14	Sharpness		p.41
15	Image quality		p.37-38
16	Image size	1600, 1024, 800, 640	p.37
17	Number of available shots remaining	9	
	Remaining time(Movie clip/ Voice recording)	00:01:00/00:10:00	p.22-23
18	Autofocus frame	[]	
19	Digital Zoom rate	X2.0	p.26
20	Optical zoom indicator		

Starting the recording mode

- If the memory card is inserted in the camera, all the camera functions apply only to the memory card.
- If the memory card is not inserted in the camera, all the camera functions apply only to the internal memory.

■ Recording a still image

1. Insert the batteries (p.16). Insert the batteries taking note of the polarity (+ / -).
2. Insert the memory card (p.19).

As this camera has a 6MB internal memory, you do not need to insert the memory card. If the memory card is not inserted, an image will be stored in the internal memory. To expand memory capacity, insert a memory card. If the memory card is inserted, an image will be stored on the memory card.

3. Close the battery chamber cover.
4. Press the power button to turn on the camera. If the date/time that is displayed on the LCD monitor is incorrect, reset the date/time before taking a picture. (p.65)
5. Select the STILL IMAGE() mode by rotating the mode dial.
6. Point the camera towards the subject and compose the image by using either the viewfinder or LCD monitor.
7. Press the shutter button to capture an image.

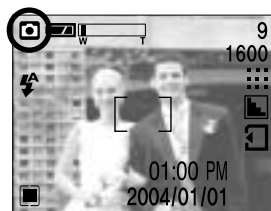
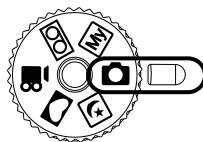

[STILL IMAGE mode]

Starting the recording mode

■ Using MySET Mode

This mode allows users to save frequently used shooting settings for later use. Steps 1 through 4 are the same as for shooting still images.

5. Rotate the Mode Dial to MySET mode ().

6. You can use the menus that appear when you press camera and menu buttons to change the desired camera functions. The last changed function(s) will automatically be saved as MySET mode.

7. If you rotate the Mode Dial to MySET mode () while in another camera operation mode, the camera settings will switch to the settings you changed in Step 6.

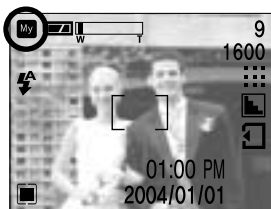
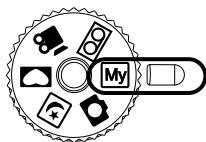

■ Recording Voice

Steps from 1-4 are the same as those for recording a still image.

5. Select the VOICE RECORDING()mode by rotating the mode dial.

6. Press the shutter button to record a voice.

- Press the shutter button once and a voice is recorded for as long as the available recording time(Max : 1hour) allows. The recording time will be displayed on the LCD monitor.

- A voice will still be recorded if the shutter button is released.

- If you wish to stop recording, press the shutter button again.

- File type : *.wav

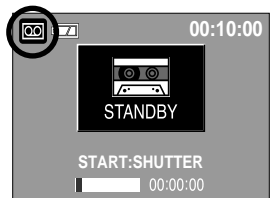
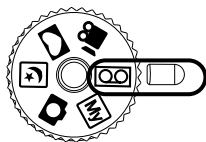

[VOICE RECORDING mode]

Starting the recording mode

■ Recording a Movie clip

Steps from 1-4 are the same as those for recording a still image.

5. Select the MOVIE CLIP () mode by rotating the mode dial.
6. The MOVIE CLIP mode icon and available recording time will display on the LCD monitor.
7. Point the camera towards the subject and compose the image by using either the viewfinder or LCD monitor. Press the shutter button and movie clips are recorded for as long as the available memory permits. Movie clips will still be recorded if the shutter button is released.

Movie clip recording time will be displayed on the LCD monitor.

- If you wish to stop recording, press the shutter button again.
- Image size and type are listed below.

- Image size : 320 x 240

- File type : *.MOV

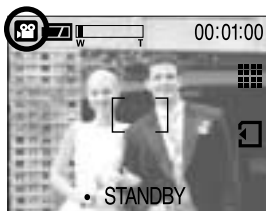



[MOVIE CLIP mode]

■ Pausing while recording a movie clip (Successive Recording)

This camera allows you to temporarily stop during unwanted scenes, while recording a movie clip. Using this function, you can record your favorite scenes into a movie clip without having to create multiple movie clips.

● Using Successive Recording

Steps 1 through 6 are the same as those for recording a movie clip.

7. Compose the image by using either the viewfinder or LCD monitor and press the Shutter button. Recording will continue for the duration of available recording time. The recording will continue even if you release the finger from the Shutter button.
8. Press the Play & Pause () button to pause recording.
9. Press the Play & Pause () button again to resume recording.
10. To stop recording the movie clip, press the Shutter button again.

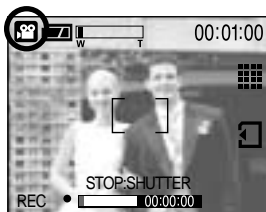

[Successive recording of a movie clip]

Starting the recording mode

INFORMATION

- When the Flash Off or Slow synchro mode is selected in a low lighting condition, the camera shake warning indicator () may appear on the LCD monitor. In this case, use a tripod, support the camera on a solid surface or change the flash mode to flash shot mode.
- Backlight compensated shots : When taking an outdoor shot, avoid facing the sun, as the image may be dark because of the strong backlight. In backlight conditions, please use Fill-in flash(p.30), Spot metering(p.39) or Exposure compensation(p.33).
- Avoid obstructing the lens or the flash when you capture an image.
- As there can be some differences between what is seen through the Viewfinder and the resulting image when taken at a range closer than 1.5m, it is recommended that you use the LCD monitor to compose these shots.
- Using the LCD monitor extensively will drain the batteries.
We recommend turning off the LCD monitor and using the optical viewfinder as often as possible in order to extend battery life.
- Under certain conditions the focus system may not perform as expected.
 - In Macro focus mode, if the distance from a subject is closer than 0.15m or farther than Macro focus 0.8m.
Keep the distance between 0.15m~0.8m in Macro focus mode.
 - In Normal focus mode, if the distance from a subject is closer than 0.8m.
Keep the distance between 0.8m ~ Infinity in Normal focus mode.

Using the camera buttons to adjust the camera

- The RECORDING mode function can be set up by using the camera buttons.

POWER button

- Used for turning the camera's power on / off.
- If there is no operation during the specified time, the camera's power will be turned off automatically to save battery life.

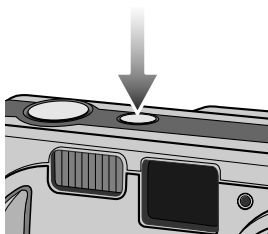

SHUTTER button

- Used for taking an image or recording voice in the RECORDING (STILL IMAGE, VOICE RECORDING, MOVIE CLIP) mode.
- In MOVIE CLIP mode :
Pressing the shutter button down fully starts the process for recording a movie clip. Press the shutter button once and the movie clip is recorded for as long as the available recording time in the memory allows. If you wish to stop recording, press the shutter button again.

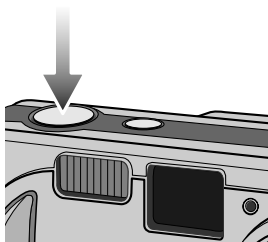

WIDE / TELE button

- If the menu is not displayed, this button works as the OPTICAL ZOOM or DIGITAL ZOOM button.

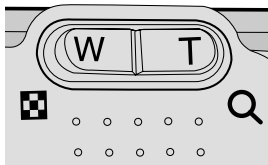

WIDE / TELE button

- This camera has a 2X optical zoom and a 2X digital zoom function. Using both will offer a total zoom ratio of 4X. When you press the zoom (W/T) button, the zoom bar will display in the upper center part of the LCD monitor.

● TELE Zoom

Optical zoom TELE

: Pressing the zoom button T. This will zoom into the subject i.e. the subject will appear nearer.

Digital zoom TELE

: When the maximum (2X) optical zoom is selected, pressing the zoom button T activates the digital zoom software. Releasing zoom button T stops the digital zooming at the required setting. Once the maximum digital zoom (2X) is achieved, pressing the zoom button T will have no effect. You can check the digital zoom rate with the [X1.1 ~ X 2.0] numerical mark next to the zoom bar.

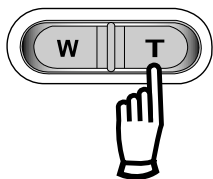

[WIDE zoom]



[TELE zoom]

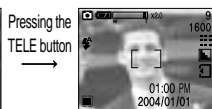

[Digital zoom 2.0X]

● WIDE Zoom

Optical zoom WIDE

: Pressing the zoom button W. This will zoom out from the subject i.e. the subject will appear further away. Pressing the W button continuously will set the camera to its minimum zoom setting i.e. the subject appears at its furthest from the camera.

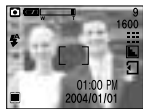
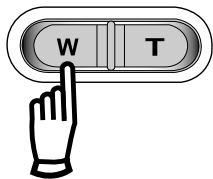

[TELE zoom]

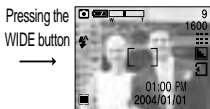

[Optical zoom 1.5X]

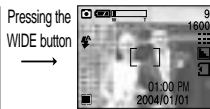

[WIDE zoom]

Digital zoom WIDE

: When the digital zoom is in operation, pressing the zoom button W will reduce the digital zooming in steps. Releasing zoom button W stops digital zooming. Pressing the W button will reduce the digital zoom and then it will continue to reduce the optical zoom until the minimum setting is reached.

Optical zoom



[Digital zoom 2.0X]



[Digital zoom 1.5X]

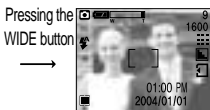



[TELE zoom]

WIDE / TELE button

INFORMATION

- To use the digital zoom the LCD monitor has to be turned on.
- Images taken using the digital zoom may take a little longer for the camera to process. Allow time for this to take place.
- The digital zoom cannot be used in movie clip shots.
- Digital Zoom will not work in Night Scene mode.
- You may notice a decrease in image quality when using the digital zoom.
- When the maximum(2X) optical zoom is selected, pressing the zoom button T increases the digital zoom ratio by 0.1 steps.
- If the movie clip is being recorded, the zoom operation cannot be activated.
- Take care not to touch the lens to avoid taking an unclear image and possibly causing camera malfunction.
If the image is dim, turn the camera power off and on again to modify the lens position.
- Take care not to press the lens as this may cause a camera malfunction.
- When the camera is turned on, take care not to touch the camera's moving lens parts as this may cause the resulting image to be dim and unclear.
- Take care not to touch the lens during zoom operation as this may cause damage.

Voice memo()/ UP button

- While the menu is showing, press the UP button to move up the submenu cursor.
 - When the menu is not displayed on the LCD monitor, the UP button operates as the voice memo() button. You can add your voice-over to a stored still image.
- Recording a voice memo
 1. Select STILL IMAGE mode by rotating the mode dial.
 2. Press the VOICE MEMO() button. If the voice memo indicator is displayed on the LCD monitor, the setting is completed.

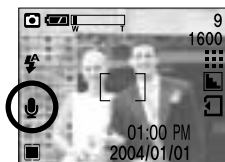
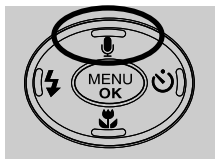

[Preparing for Voice Memo]



[Recording Voice Memo]

Voice memo() / UP button

3. Press the shutter button and take a picture. The picture is stored on the memory card.
4. Voice memo will be recorded for ten seconds from the moment the picture is stored.
In the middle of the sound recording, pressing the shutter button will stop the voice memo.

Macro() / Down button (Focusing)

- While the menu is showing, press the DOWN button to move from the main menu to a submenu, or to move down the submenu cursor.
- When the menu is not showing, you can use the MACRO ()/DOWN button to take macro pictures (within the distance range of 0.15~0.8 m for WIDE and 0.6~0.8 m for TELE) in the STILL IMAGE mode.

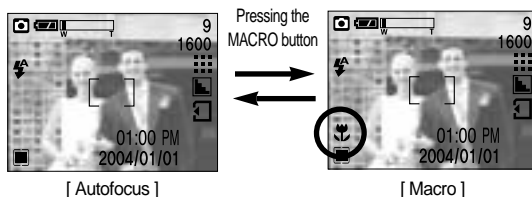
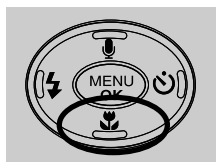

INFORMATION

- When the macro mode is selected, it is possible that camera shake will occur.
If this is the case, use a tripod to eliminate this.
- When the macro mode is selected, it is recommended that you use the LCD monitor to compose these shots.

Focus lock

■ To focus on the subject positioned outside of the center, use the focus lock function.

● Using the Focus Lock

1. Ensure the subject in the center of the autofocus frame.
2. Press the SHUTTER button halfway. The Autofocus frame(green) will light up, indicating that the camera is in focus. Be careful not to press the SHUTTER button all the way down to avoid taking an unwanted picture.
3. With the SHUTTER button still pressed down only halfway, move the camera to recompose your picture as desired, and then press the SHUTTER button completely to take the picture. If you release your finger from the SHUTTER button, the focus lock function will be canceled.

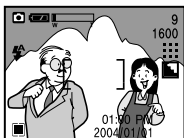

[The image to be captured]

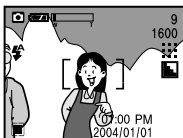

[Press the SHUTTER button halfway and focus on the subject]

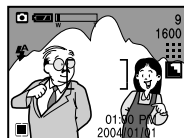

[Recompose the picture and fully depress the SHUTTER button]

FLASH(⚡) / LEFT button

- When the menu is displayed on the LCD monitor, pressing the LEFT button makes the cursor shift to the left tab.
- When the menu is not displayed on the LCD monitor, the LEFT button operates as the FLASH (⚡) button.

● Selecting the flash mode

1. Rotate the mode dial to select the STILL IMAGE mode.
2. Press the Flash(⚡) button until the desired flash mode indicator displays on the LCD monitor.
3. A flash mode indicator will be displayed on the LCD monitor.
Use the correct flash to suit the environment.

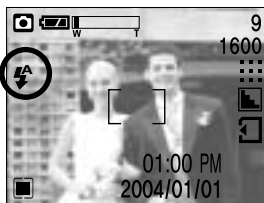

[Selecting the Auto flash]







● Flash range

(Unit : m)

ISO	AUTO FOCUS		MACRO	
	WIDE	TELE	WIDE	TELE
AUTO	0.8~3.0	0.8~2.5	0.15~0.8	0.6~0.8

FLASH(⚡) / LEFT button

- Flash mode indicator

ICON	Flash mode	Description
	Auto flash	If the subject or background is dark, the camera flash will operate automatically.
	Red eye reduction	If a subject or background is dark, the camera flash will work automatically and will reduce the red-eye effect by using the red-eye reduction function.
	Fill in flash	The flash fires regardless of available light. The intensity of the flash will be controlled, according to the prevailing conditions. The brighter the background or subject is, the less intense the flash will be.
	Slow synchro	The flash will operate in conjunction with a slow shutter speed in order to obtain the correct exposure. We recommend using a tripod for this function. When you take an image in a condition with poor light, the camera shake warning indicator () will display on the LCD monitor.
	Flash off	The flash does not fire. Select this mode when capturing images in a place or situation where flash photography is prohibited. When you capture an image in a poorly lit condition, the camera shake warning indicator () will display on the LCD monitor.

INFORMATION







- Using the flash frequently will reduce the life of the batteries.
- Under normal operating conditions the charging time for the flash is normally within 8 seconds. If the batteries are weak, the charging time will be longer.
- During the movie clip mode, the flash function will not operate.
- Take photographs within the flash range.
- The image quality is not guaranteed if the subject is too close or highly reflective.
- The LCD monitor is turned off for a while after using the flash to recharge it.

Self-timer(☺) / Right button

■ When the menu is displayed on the LCD monitor, pressing the Right button makes the cursor shift to the sub tab.

■ When the menu is not displayed on the LCD monitor, the RIGHT button operates as the Self-timer(☺) button. This function is used when the photographer would also like to be in the image.

● Self-timer Types by Available Mode

Self-timer \ Camera mode						
2SEC	○	×	×	○	○	○
10SEC	○	×	○	○	○	○
Double	○	×	×	○	○	○

● Selecting the self-timer

1. Rotate the MODE DIAL to select a recording mode other than Voice Recording mode.

2. Press the SELF-TIMER button until the desired mode indicator displays on the LCD monitor.

A 10 second, 2 second or Double self-timer icon appears on the LCD monitor. In Movie Clip mode, only the 10-second self-timer will work.

• 10SEC self-timer(☺) :

Pressing the shutter button will allow an interval of 10 seconds before the image is taken.

• 2SEC self-timer(☺^{2S}) :

Pressing the shutter button will allow an interval of 2 seconds before the image is taken.

• Double self-timer(☺²) :

A picture will be taken after about 10 seconds and 2 seconds later a second picture will be taken. When using the flash, the 2-second self-timer may be delayed for longer than 2 seconds depending on the flash charge time.

3. When you press the SHUTTER button, the picture will be taken after the specified time has elapsed.

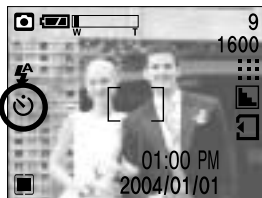
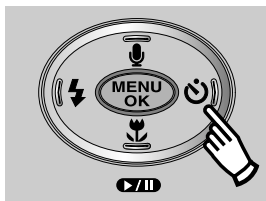

[Selecting the 10SEC self-timer]

Self-timer(☺) / Right button

INFORMATION

- The default is OFF.
- When taking a picture using the self-timer, the self-timer lamp works as follows:
 - 10 second self-timer setting : The self-timer lamp blinks at 1 second intervals for the first 7 seconds. It blinks at 0.5 second intervals for the remaining 3 seconds.
 - 2 second self-timer setting : The self-timer lamp blinks at 0.5 second intervals for 2 seconds.
- If you operate the Power button, Mode dial and Self-timer button during the self-timer operation, the self-timer function is cancelled.
- Use a tripod to prevent the camera from shaking.

MENU/ OK button

- If the menu is displayed, use the 5-Function buttons to change the data values and for your changes to be accepted.
- If the menu is not displayed, press the MENU/OK button to display a menu for the current camera mode on the LCD monitor. Press the button again to return to the previous state.

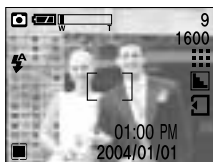

[Menu off]

Pressing the
MENU
button

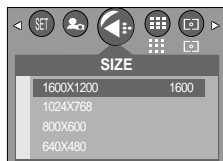



[Menu on]

+/- button

- You can use the +/- button to adjust the values for the exposure compensation.
- Exposure compensation : This camera automatically adjusts the exposure according to the ambient lighting conditions. You can also select the exposure value by using the +/- button. In Still image, MySET and Photo Frame mode, the exposure compensation can be adjusted between -2.0EV and +2.0EV (at 0.5EV increment), and in Night Scene mode, you can set the Longtime shutter.

● Compensating Exposure

1. When you press the +/- button, the exposure compensation menu bar and the exposure compensation icon () will appear as shown.
2. Use the LEFT and RIGHT buttons to set the desired exposure compensation factor (Δ EV).
3. Press the +/- button again. The value you set will be saved and the Exposure Compensation setup mode will close. If you change the exposure value, the exposure indicator () will be displayed on the bottom of the LCD monitor.

● Setting the Long-time Shutter (Night Scene mode)

1. Turn the Mode Dial to select Night Scene mode.
2. Press the +/- button. Available shutter speeds will be displayed as shown in the picture.
3. Use the LEFT and RIGHT buttons to select the desired shutter speed.
4. Press the +/- button. The menu will disappear and the long-time shutter speed will be set. Then the long-time shutter icon (**LT**) will be displayed at the bottom right of the LCD monitor.

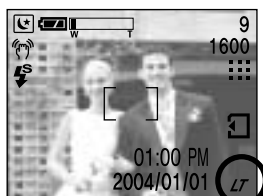
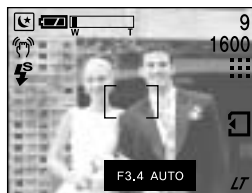
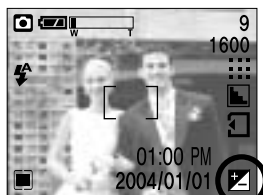
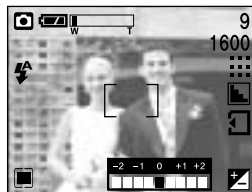

INFORMATION

- A negative exposure compensation value reduces the exposure. Note that a positive exposure compensation value increases the exposure and the LCD monitor will appear white or you may not get good pictures.

LCD button

- You can check the recording status in the LCD monitor.
Each time you press the LCD button in a recording mode, except Voice Recording mode, the LCD monitor display changes as follows:

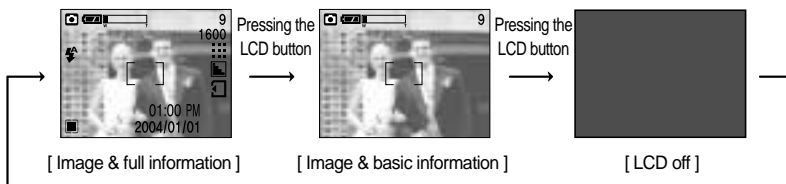
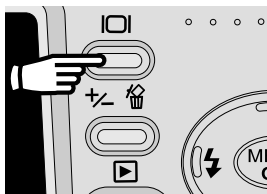

Pressing the LCD button



















Using the LCD monitor to adjust the camera settings

- You can use the menu on the LCD monitor to set up recording functions.













INFORMATION

- The menu will not be displayed on the LCD monitor in the following circumstances:
 - When another button is being operated.
 - While image data is being processed.
(when the camera status lamp next to the viewfinder illuminates)
 - When there is no battery capacity.
- When the menu is showing on the LCD monitor, it is not possible to operate the shutter button i.e. capture an image. To capture an image, simply cancel the menu display by pressing the MENU button.

- The following functions are available, depending on the mode you have selected.
The items indicated by are default settings.

Menu tab	Main menu	Sub menu	Camera working mode
	SIZE	1600X1200	   My
		1024X768	
		800X600	
		640X480	
	QUALITY	S.FINE	   My
		FINE	
		NORMAL	
		HIGH	
		LOW	
	METERING	MULTI	  My
		SPOT	
	SHOOTING	SINGLE	  My
		CONTINUOUS	
		AEB	
	SHARP	SOFT	  My
		NORMAL	
		VIVID	

Using the LCD monitor to adjust the camera settings

Menu tab	Main menu	Sub menu	Camera working mode	
	EFFECT	NORMAL	   	
		B&W		
		SEPIA		
	W.BALANCE	AUTO	DAYLIGHT	   
		CLOUDY	SUNSET	
		FLUORESCENT	TUNGSTEN	
		CUSTOM		
	PHOTO FRAME	FRAME 1~9		

How to use the menu

1. Turn on the camera and press the MENU button. A menu for each camera mode appears. However, there is no menu for Voice Recording mode ().
2. Use the LEFT and RIGHT buttons to navigate through the menus.



3. Use the UP and DOWN buttons to select a sub menu.

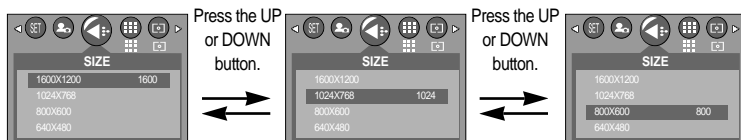

4. Select a sub menu, and then press the OK button. The value you set will be saved and the menu will disappear.

Size

- You can select the image size appropriate for your application. You can select from STILL IMAGE, PHOTO FRAME, NIGHT SCENE and MySET modes.

Icon	1600	1024	800	640
Size	1600x1200	1024x768	800x600	640x480

- The higher the resolution, the lower the number of available shots will be because high resolution images require more memory than lower resolution images.

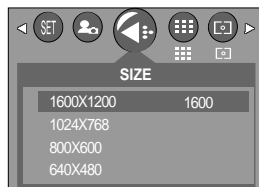

[STILL IMAGE mode]

Quality

- You can select the compression ratio appropriate for your application of the captured images. The higher the compression ratio, the lower the picture quality. You can select from STILL IMAGE, MOVIE CLIP, PHOTO FRAME, NIGHT SCENE and MySET modes.

Mode	STILL IMAGE mode			MOVIE CLIP mode	
	Icon	Icon	Icon	Icon	Icon
Sub menu	S.FINE	FINE	NORMAL	HIGH	LOW
File Format	jpeg	jpeg	jpeg	mov	mov

※ fps : frame per second



[STILL IMAGE mode]

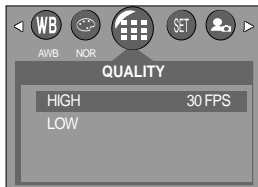

[MOVIE CLIP mode]

Quality

- Image Size and Quality for the Number of Images that can be saved in a Memory Card/Shooting Time (When using a 6MB internal memory ; based on Samsung's own testing). These figures are approximate as image capacities can be affected by variables such as subject matter.

Mode	STILL IMAGE mode				MOVIE CLIP mode
	1600	1024	800	640	320 x 240
S.FINE	6	15	25	40	-
FINE	10	26	43	64	-
NORMAL	16	40	64	92	-
HIGH	-	-	-	-	About 1 minute 10 Seconds
LOW	-	-	-	-	About 2 minute 20 Seconds

INFORMATION

- S.FINE is the highest quality and NORMAL is the lowest setting. Choose the setting appropriate for your needs.
- This file format complies with the DCF(Design rule for Camera File system).
- JPEG (Joint Photographic Experts Group): JPEG is the image compression standard developed by the Joint Photographic Experts Group. This type of compression is most commonly used for compressing photos and graphics because it can compress the files efficiently without damaging the data.

Metering

- If you cannot obtain suitable exposure conditions, you can change the metering method to take brighter pictures. You can select from STILL IMAGE, PHOTO FRAME and MySET modes.

MULTI() : Exposure will be calculated based on an average of the available light in the image area. However, the calculation will be biased towards the centre of the image area. This is suitable for general use.

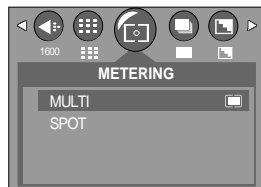

[STILL IMAGE mode]

Metering

- SPOT () : The indicated area at the centre will be metered, as shown on the right. This is suitable when the subject at the center is exposed correctly regardless of back lighting.



[Spot metering zone]

INFORMATION

- If the subject is not the centre of the focus area, do not use the spot metering as this may result in an exposure error. In this circumstance, rather use exposure compensation.

Shooting

- You can select continuous shooting or AEB(Auto Exposure Bracket) shooting in this menu. If you select CONTINUOUS or AEB, the flash will automatically be set to Flash Off.

SINGLE : A picture will be taken each time you press the Shutter button.

CONTINUOUS : As many pictures as the number of shots you have set will be taken when the Shutter button is pressed once. Use this to take pictures of moving objects/people.

AEB : 3 pictures will be taken continuously, 1 overexposure (+0.5EV), 1 normal exposure (0.0EV), and 1 underexposure (-0.5EV) respectively. Use this when it is difficult to determine the exposure level of the subject.



[STILL IMAGE mode]

- If you press the OK button after selecting CONTINUOUS, the screen shown on the side will appear on the LCD monitor. Press the UP/DOWN button to select the desired number of continuous shots and press the OK button.



[STILL IMAGE mode]

Shooting

■ Examples of Picture Exposure



[Underexposure]



[Normal Exposure]



[Overexposure]

INFORMATION

- To take continuous shots, the number of available shots must be more than 2 because the minimum numbers of continuous shots permitted are 2. To take the AEB shots, the number of available shots must be more than 3 because of the same reason.
- Camera shake can be a problem when using the AEB shooting mode and it takes time to store the AEB image to the memory. We recommend using a tripod.
- In continuous shot and AEB mode, the digital zoom function will not operate.
- Size and Quality to the Number of Continuous Shooting Images (based on our own testing).

		D250			
Quality \ Size		1600X1200	1024X768	800X600	640X480
Super fine		2	3	4	5
Fine		3	4	5	6
Normal		4	5	6	7

Sharpness

- You can adjust the sharpness of the picture you want to take. You cannot check the sharpness effect on the LCD monitor before you take a picture, because this function is applied only when the captured image is stored on the memory.

You can select from STILL IMAGE, PHOTO FRAME and MySET modes.

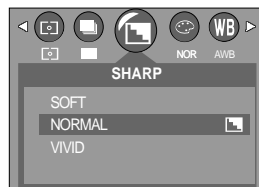

[STILL IMAGE mode]

Sub menu	Icon	Description
SOFT		The edges of the image are softened. This effect is suitable for editing images on your PC.
NORMAL		The edges of the image are sharp. This is suitable for printing.
VIVID		The edges of the image are emphasized. The edges will appear sharp, but noise may occur in the recorded image.

Effect

- By using the camera's digital processor, it is possible to add special effects to your images. You can select from STILL IMAGE, MOVIE CLIP, PHOTO FRAME and MySET modes.

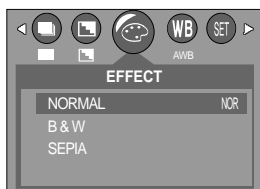

[STILL IMAGE mode]

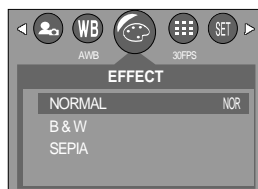

[MOVIE CLIP mode]

- NORMAL** : No effect is added to the image.
- B&W** : Converts the image to black and white.
- SEPIA** : Captured images will be stored in a sepia tone (a gradient of yellowish brown colours).

White balance

- White balance : The white balance control allows you to adjust the colours to appear more natural looking. The White Balance is available in STILL IMAGE, PHOTO FRAME, MOVIE CLIP and MySET mode.

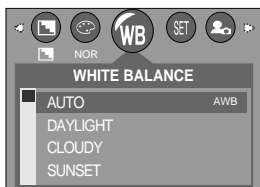

[STILL IMAGE mode]

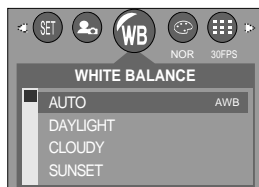

[MOVIE CLIP mode]

● White balance

- AUTO AWB : The camera automatically selects the appropriate white balance settings, depending on the prevailing lighting conditions.
- DAYLIGHT ☀ : For taking images outside.
- CLOUDY ☁ : For taking images under a cloudy and overcast sky.
- SUNSET 🌇 : For taking images at sunset.
- FLUORESCENT 💡 : For shooting under fluorescent lighting.
- TUNGSTEN 🔦 : For shooting under tungsten (standard light bulb) lighting.
- CUSTOM 🎛 : Allows the user to set the white balance according to the shooting condition.

Different lighting conditions may cause a colour cast on your images.

● Using the Custom White Balance

The White Balance settings may vary slightly depending on the shooting environment. You can select the most appropriate white balance setting for a given shooting environment by setting up the custom white balance.

1. Select the CUSTOM menu of the White Balance.
2. Place a sheet of white paper in front of the camera so that the LCD monitor shows only white, and then press the SHUTTER button.
3. The custom white balance value will be saved and the menu will disappear.
 - The custom white balance value will be applied, starting with the next picture you take.

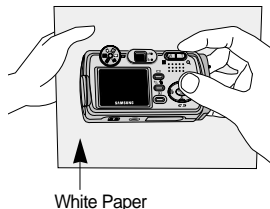



Photo Frame

- You can add 9 types of frame-like borders to a still image you want to capture. This can be set in Photo Frame mode.

● Selecting a Photo Frame

1. Rotate the Mode Dial to Photo Frame mode ().
2. Press the MENU button, and then use the LEFT and RIGHT buttons to select [PHOTO FRAME].
3. Press the UP/DOWN button to select the desired photo frame, and then press the OK button.

- When you press the Shutter button half-way, autofocus will be performed and the selected photo frame will appear simultaneously.

- You can check the photo frame you added to pictures in Quick View or Play mode.

- Available photo frames are as follows:

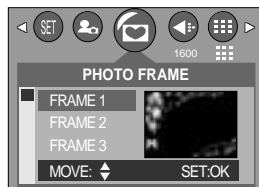

[FRAME 1]



[FRAME 2]



[FRAME 3]



[FRAME 4]



[FRAME 5]



[FRAME 6]



[FRAME 7]



[FRAME 8]



[FRAME 9]

Starting play mode

- Turn the camera on and select Play mode by pressing the play mode button ().
The camera can now play back the images stored in the memory.
- If you have turned on the camera by pressing the POWER button, you can press the PLAY MODE button once to switch to Play mode and press it again to switch to Recording mode.
You can turn the power on with the play mode button.
- You can set up the PLAY mode function by using the camera buttons and LCD monitor.

● Playing back a still image

1. Select the PLAY mode by pressing the play mode button ().



2. The last image stored on the memory is displayed on the LCD monitor.



3. Select an image that you want to play back by pressing the LEFT / RIGHT button.

※ Press and hold the LEFT or RIGHT button to play back the images quickly.

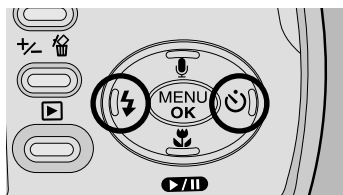



INFORMATION

- Even if the camera's power is off, you can start the play mode by pressing the play mode button.

Starting play mode

■ Playing back a movie clip

Steps from 1-2 are the same as those to play back a still image.

3. Select the recorded movie clip that you want to play back by using the LEFT/RIGHT button. If you select a movie clip, the movie clip indicator () will be displayed on the LCD monitor.
4. Press the play & pause button () to play back a movie clip file.
 - To pause a movie clip file while playing it back, press the play & pause button again.
 - Pressing the play & pause button again will cause the movie clip file to restart.
 - To stop playback of the movie clip, press the play & pause button (), and then press the LEFT or RIGHT button.

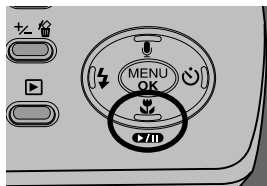

■ Playing back a recorded voice

In order to play back voice files recorded with the camera, the camera must be connected to your PC (See p.87). Your PC must have a sound card and speakers installed. Please be sure to install the camera driver before connecting the camera to your PC.

1. Connect the camera to your PC.
2. Open Windows Explorer and open the DICM/100SSCAM folder of the Removable Drive.
3. Select a voice file (*.wav).
4. Right-click and select [Copy].
5. Select the folder on your PC to which you want to save the file, right-click, and select [Paste].
6. Click on the file you just saved. The player will appear on the left side of the Explorer window.
7. Click on the Play button to play back the voice file.

* The method of playing back voice memos added to still images is the same as the method of playing back voice files.



[Play Button]

LCD monitor indicator

■ The LCD monitor displays information about the shooting conditions.



No.	Description	Icon	Page
1	Battery		p.16
2	Play mode		
3	File Type		
4	Voice memo		p.49
5	Protect indicator		p.54
6	DPOF indicator		p.59
7	Stored image number	100-0009	

■ If you press the LCD button, you can check the following recording information:

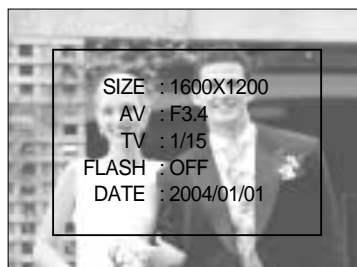

SIZE	: 1600X1200	Size
AV	: F3.4	Aperture value
TV	: 1/15	Shutter speed
FLASH	: OFF	Whether or not the flash is used.
DATE	: 2004/01/01	Recording date

Using the camera buttons to adjust the camera

- In Play mode, you can use the buttons on the camera to conveniently set up the Play mode functions.

Thumbnail () / Enlargement () button

- You can view multiple pictures, enlarge a selected picture, and crop and save a selected area of an image.

● Thumbnail display

1. While an image is displayed full screen, press the thumbnail button.
2. The thumbnail display will highlight the image that had been showing at the time the thumbnail mode was selected.
3. Press the 5 function button to move to a desired image.
4. To view an image separately, press the enlargement button ().

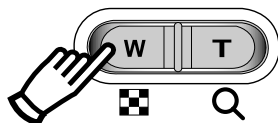

[Normal display mode]

Pressing the thumbnail button ()

← →

Pressing the enlargement button ()

Highlighted image →

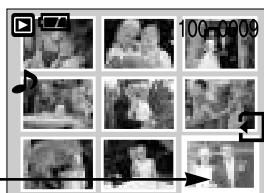

[Thumbnail display mode]

● Image enlargement

1. Select an image that you want to enlarge and press the enlargement button.
2. Different parts of the image can be viewed by pressing the 5 function button.
3. Pressing the thumbnail button will zoom back to the original full sized image.

- You can tell whether the image displayed is an enlarged view by checking the image enlargement indicator shown at the bottom left of the LCD monitor. (If the image is not an enlarged view, the indicator will not be displayed.) You can also check the area of enlargement.
- Movie clips and WAV files can't be enlarged.
- If an image is enlarged, a loss of quality may occur.

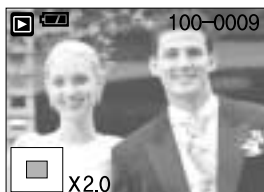
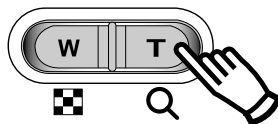

Thumbnail() / Enlargement() button

- The maximum enlargement rate in proportion to the image size.

Image size	1600	1024	800	640
Maximum enlargement rate	X5.0	X2.0	X2.0	X2.0

- Trimming : You can extract part of the image that you want and save it separately.

1. Select an image that you want to enlarge and press the enlargement button.
2. Different parts of the image can be viewed by pressing the 5 function button.
3. Press the MENU button and a message will be displayed as shown alongside.
4. OK button : The trimmed image will be saved with the last file name and displayed on the LCD monitor.
LEFT button : The trimming menu will disappear.



- ※ If there is little memory space to save the trimmed image, the image can't be trimmed.

Voice () memo / Up button

- When the menu is displayed on the LCD monitor, pressing the UP button makes the menu cursor move up.
- When the menu is not displayed on the LCD monitor, the UP button operates as the voice memo button. You can add your audio to a stored still image.

- Adding a Voice Memo to a Still Image

1. Press the LEFT/ RIGHT button to select an image that you wish to add sound to.
2. Press the voice memo button () and the voice memo indicator will display. The camera is now ready to record a voice memo.



Voice () memo / Up button

- Press the shutter button to start recording.
The [REC]message will be displayed on the LCD monitor (as shown) and voice will be recorded to the still image for 10 seconds.
- The recording can be stopped by pressing the shutter button again.
- The () icon will be displayed on the LCD monitor after voice memo recording has finished.
 - Voice memos can't be recorded onto movie clip files.
 - The voice memo will be saved in *.wav format, but has the same file name as the still image to which it corresponds.
 - If you add a new voice memo to the still image that already has a voice memo, the existing voice memo will be erased.

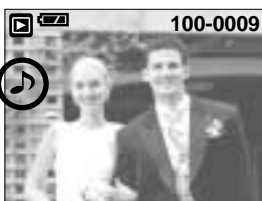

Play & Pause () / Down button

- In Play mode, the play & pause/ down button works as follows:
 - If the menu is displayed
Press the DOWN button to move from the main menu to a sub menu, or to move down the sub menu cursor.
 - If a movie clip is playing
 - In Stop mode : Plays a movie clip.
 - During playback : Temporarily stops playback.
 - In Pause mode : Resumes playback



[Movie clip is stopped]



[Movie clip is playing]



[Movie clip is paused]

LEFT / RIGHT/ MENU/ OK button

■ LEFT / RIGHT/ MENU/ OK buttons activate the following.

- LEFT button : While the menu is showing, press the LEFT button to select the menu tab to the left of the cursor.
- RIGHT button : While the menu is showing, press the RIGHT button to select the menu tab to the right of the cursor, or to move an auxiliary menu.
- MENU button : When you press the MENU button, the play mode menu will be displayed on the LCD monitor. Pressing it again will return the LCD to the initial display.
- OK button : When the menu is displayed on the LCD monitor, the OK button is used for confirming data that is changed by using the 5 function button.

LCD button

■ The shooting information will be displayed on the LCD monitor.

The last image stored in the memory is displayed on the LCD monitor by pressing the play mode button.

Pressing the LCD button in the PLAY (▶) mode will change the display as shown below. [Image & Icons] → [Image & Information] → [Image only]

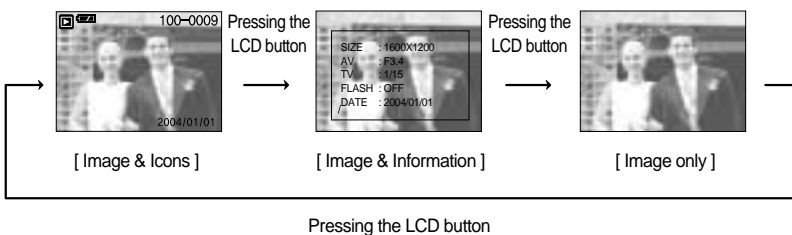
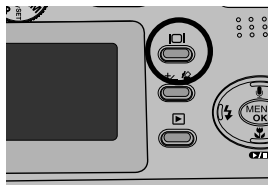

Delete () button

■ This deletes images stored on the memory card.

● Deleting Images in Play Mode

1. Select an image that you want to delete by pressing the LEFT / RIGHT button and press the DELETE () button.
2. A message will display as shown alongside on the LCD monitor.
3. Press the OK button to delete the image.

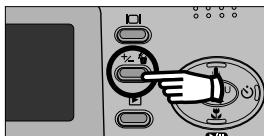







INFORMATION

- Before deleting images from the camera, you should protect (p.54) or download images (p.83) to your computer that you wish to keep.

Setting up the play back function using the LCD monitor

- PLAY mode functions can be changed by using the LCD monitor. In the PLAY mode, pressing the MENU button displays the menu on the LCD monitor. The menus you can set up in Play mode are as follows. To capture an image after setting up the play menu, press the PLAY button.

Menu tab	Main menu	Sub menu	Secondary menu	Page	
	DEL. ALL	NO		p. 53	
		YES			
	PROTECT	ONE PIC	UNLOCK	p. 54	
			LOCK		
		ALL PICS	UNLOCK		
			LOCK		
	SLIDE	OFF, 1~10SEC	REPEAT	ON	p. 55
			OFF		
	RESIZE	1024X768		p. 56	
		800X600			
		640X480			
		LOGO			
	ROTATE	OFF		p. 57	
		ON	ROTATE		
			SET		
	COPY TO CARD	NO		p. 58	
		YES			
	DPOF	STANDARD	ONE PIC	0~30 PRINTS	p. 59
			ALL PICS	0~30 PRINTS	
		INDEX	NO		
			YES		
		CANCEL	STANDARD		
			INDEX		

※ Menus are subject to change without prior notice.

Deleting all images

- Of all the files stored in the memory card, the unprotected files in the DCIM subfolder will be deleted.
- Deleting All images
 1. Press the play mode button and press the menu button.
 2. Press the LEFT/ RIGHT button and select the [DEL.ALL] menu tab.
 3. Select a desired sub menu by pressing the UP/ DOWN button and press the OK button.
 - Selecting [NO] : The [DEL.ALL] menu will disappear.
 - Selecting [YES] : When you press the OK button, a [PLEASE WAIT!] message will display while all the unprotected images are deleted.
 4. If there aren't protected images, all the images are deleted and a [NO IMAGE!] message will display.



INFORMATION

- Remember that this will permanently delete unprotected images. Important shots should be stored on a computer before deletion takes place.
- The startup image is stored in the camera's system(i.e., not on the internal memory or memory card) and it will not be deleted even if you delete all files on the memory.

Protecting images

- This is used to protect specific shots from being accidentally erased (LOCK). It also unprotects images that have been previously protected (UNLOCK).

● Protecting Images

1. Press the play mode button and press the menu button.
2. Press the LEFT/ RIGHT button and select the [PROTECT] menu tab.
3. Select a desired sub menu by pressing the UP/ DOWN button and press the OK button.

- [ONE PIC] : Only an image that is displayed on the LCD monitor is protected or unprotected.
- [ALL PICS] : All of the stored images are protected or unprotected.

4. Select the desired secondary menu by pressing the UP/DOWN button and press the OK button.

- [UNLOCK] : Cancels the protect function.
- [LOCK] : Sets up the protect function.

- If you select the [ONE PIC] sub menu at step 3, you can protect or unprotect another image by pressing the LEFT/ RIGHT button.

- If you protect an image, the protect icon () will be displayed on the LCD monitor.

(An unprotected image has no indicator)

- An image in LOCK mode will be protected from [DELETE] or [DELETE ALL] functions, but will NOT be protected from the [FORMAT] function.

5. Press the shutter button and the menu will disappear.

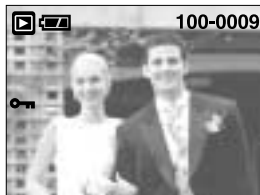

Starting the slide show

■ Images can be displayed continuously at pre-set intervals. You can view the slide show by connecting the camera to an external monitor. (p.67)

1. Press the play mode button and press the menu button.
2. Press the LEFT/ RIGHT button and select the [SLIDE] menu tab.
3. Press the DOWN button.
4. Use the UP and DOWN buttons to select the desired submenu value, and then press the RIGHT button.
 - Slide Show Display Interval : OFF, 1~10SEC
5. Use the UP and DOWN buttons to select the Repeat Slide Show menu.
 - [ON] : Even once a cycle(from the first image to the last image) is completed, the slide show will continue to repeat itself.
 - [OFF] : If a cycle is completed, the slide show will stop automatically.
6. Press the OK button and the slide show will start.
 - To pause the slide show, press the play & pause button.
 - To start the slide show again, press the play & pause button again.
 - Press the menu button again and the slide show will stop.



INFORMATION

- The loading time depends on the image size and quality.
- The slide show will start from an image that was displayed on the LCD monitor. The auto power off function can't be activated.
- While the slide show is playing, only the first frame of an mov file is displayed.

Resizing

- A stored image size can be changed and used as a logo image.

The resized image will have a new file name.

1. Press the play mode button and press the menu button.
2. Press the LEFT/ RIGHT button and select the [RESIZE] menu tab.
3. Select a desired sub menu by pressing the UP/ DOWN button and press the OK button.



- RESIZE table

Size	1024x768	800x600	640x480	LOGO
1600	O	O	O	O
1024	X	O	O	O
800	X	X	O	O
640	X	X	X	O

INFORMATION

- A large sized image can be resized to a smaller sized image, but not vice versa.
- Only JPEG files can be resized. MOV and WAV files cannot be resized.
- If the memory capacity is insufficient to store the resized image, a [CARD FULL!] message will display on the LCD monitor and the resized image will not be stored.

Rotating an image

■ You can rotate the stored images by 90, 180, or 270 degrees.

1. Press the play mode button and press the menu button.
2. Press the LEFT/ RIGHT button and select the [ROTATE] menu tab.
3. Select a desired sub menu by pressing the UP/ DOWN button.

If [OFF] is selected:

Press the OK button to cancel the image rotation.

If [ON] is selected:

When you press the OK button, a menu confirming the image rotation will appear.

Press the UP/DOWN button to select [ROTATE], and then press the OK button. The image will rotate 90 degrees. If you press the OK button while ROTATE is selected, the image will rotate 90 degrees at a time.

When the image is rotated to the desired angle, press the UP/DOWN button to select [SET] and then press the OK button.

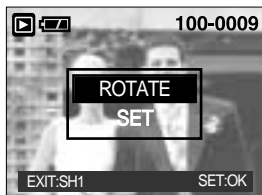
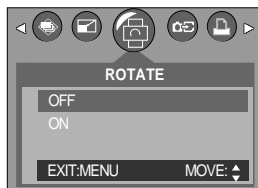

[Rotated 90 degrees]



[Rotated 180 degrees]



[Rotated 270 degrees]

4. The rotated image will be saved with a new file name and the menu screen will disappear.
 - If you display the rotated image on the LCD monitor, empty spaces may appear to the left and right of the image.
 - If memory space is insufficient, the [CARD FULL!] message will be displayed and you will not be able to rotate the image.
 - Press the SHUTTER button to switch to Play mode.

Copying

■ This enables you to copy image files to the memory card.

● Copy to card

1. Press the play mode button and press the MENU button.
2. Select the [COPY TO CARD] menu tab by pressing the LEFT/ RIGHT button.
3. Select the desired sub menu by pressing the UP/DOWN button and press the OK button.
 - If [NO] is selected: Images will not be copied to the card and the mode will switch to PLAY mode.
 - If [YES] is selected: All images on the internal memory will be copied to the memory card.

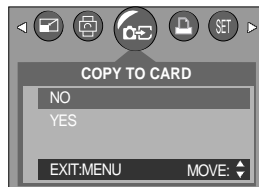

INFORMATION

- This function will not work without the card inserted into the camera.
- When you perform [COPY TO CARD], if the amount of free space on the memory card is less than the total size of the images you selected from the internal memory (6MB), only as many images as space allows will be copied. After the images have been copied, if there is insufficient memory space, the [CARD FULL!] message will be displayed when you rotate the Mode Dial to Movie Clip or Still Image. Please be sure to delete any unnecessary images to free up space before inserting the memory card into the camera.
- When you move the images that are stored in the internal memory by doing [COPY TO CARD] to the card, 101SSCAM folder will be created in the card to avoid duplication of the sub folder name. Whenever you carry out the [COPY TO CARD] function, the number of SSCAM folder increases. (Ex : 100SSCAM, 101SSCAM, 102SSCAM, 103SSCAM...) After completing [COPY TO CARD], the last stored image of the last copied folder is displayed on the LCD monitor. When you take an image, the image is stored in the last copied folder.

DPOF : Setting the Number of Copies to Print

■ DPOF

- DPOF(Digital Print Order Format) allows you to embed printing information on your memory card. Select the pictures to be printed and how many prints to make.
(Print quantity : 0 ~ 30)
- The DPOF indicator will display on the LCD monitor when an image that has DPOF information plays back. Images can then be printed on DPOF printers, or at an increasing number of photo laboratories.

- This function allows you to embed print quantity information on your memory card.
- This function does not work with MOV and WAV files.
- The DPOF file is only stored on the memory card.

■ Specifying the Number of Prints

1. Press the play mode button and press the menu button.
2. Press the LEFT/ RIGHT button and select the [DPOF] menu tab.
3. Select the [STANDARD] menu by pressing the UP/ DOWN button and press the RIGHT button.
4. Use the UP and DOWN buttons to select [ONE PIC] or [ALL PICS], and then press the OK button. A window for selecting numbers of copies will appear.

[ONE PIC] : Set the number of copies to print for the current picture only.

[ALL PICS] : Set the number of copies to print for each picture, excluding movie clips and voice recordings.

5. Use the UP and DOWN buttons to select the number of copies and then press the OK button.
 - If you selected [ONE PIC] in Step 4, you can use the LEFT and RIGHT buttons to set the number of copies to print for the previous or the next picture. Press the SHUTTER button. The Number of Copies setup menu will disappear.
 - If you selected [ALL] in Step 4, the Number of Copies setup menu will disappear.
 - The DPOF icon () will appear by the pictures for which the number of copies to print is set.



DPOF : INDEX

■ Images (except for movie clips and voice files) are printed as index type.

1. Press the play mode button and press the menu button.
2. Press the LEFT/ RIGHT button and select the [DPOF] menu tab.
3. Select the [INDEX] menu by pressing the UP/ DOWN button and press the RIGHT button.
4. Select a desired sub menu by pressing the UP/ DOWN button.

If [NO] is selected : The image will be printed in standard print format.

If [YES] is selected : The image will be printed in index format.

5. Press the OK button to confirm the setting.



DPOF : CANCEL

■ You can cancel the [STANDARD] or [INDEX] settings.

1. Press the play mode button and press the menu button.
2. Press the LEFT/ RIGHT button and select the [DPOF] menu tab.
3. Select the [CANCEL] menu by pressing the UP/ DOWN button and press the RIGHT button.
4. Select a desired sub menu by pressing the UP/ DOWN button.

If [STANDARD] is selected : Cancels the standard print setting.

If [INDEX] is selected : Cancels the index print setting.

5. Press the OK button to confirm the setting.









Setup menu

■ In this mode, you can set up basic settings.

You can use the setup menu in all camera modes, except Voice Recording mode.

The items indicated by  are default settings.

Menu tab	Main menu	Sub menu	Secondary menu	Page
	FILE	 RESET		p.62
		SERIES		
	PWR OFF	CANCEL, 1 ~  3 ~ 10MIN		p.63
	LANGUAGE	ENGLISH		p.64
		한국어		
		FRANÇAIS		
		ITALIANO		
		DEUTSCH		
		ESPAÑOL		
		繁體中文		
		简体中文		
	THAI			
	FORMAT	 NO		p.64
		YES		
	DATE	04/01/01 13:00		p.65
		 YY/MM/DD		p.65
		MM/DD/YY		
		DD/MM/YY		
	IMPRINT	 OFF		p.65
		DATE		
D&TIME				
BEEP	OFF		p.66	
	 ON			

Setup menu

Menu tab	Main menu	Sub menu	Secondary menu	Page
	LCD	DARK		p.66
		NORMAL		
		BRIGHT		
	VIDEO	NTSC		p.67
		PAL		
	Q.VIEW	OFF, 1, 2, 3SEC		p.68
	RESET	NO		p.68
		YES		
	LATEST	NO		p.69
		YES		

File name

■ This function allows the user to select the file naming format.

● Assigning File Names

1. In any mode with the exception of Voice Recording mode, press the MENU button.
2. Press the LEFT/ RIGHT button and select the [SETUP] menu tab.
3. Select the [FILE] menu by pressing the UP/ DOWN button and press the RIGHT button.
4. Select a desired sub menu by pressing the UP/ DOWN button and press the OK button.

[RESET] : After using the reset function, the next file name

will be set from 0001 even after formatting, deleting all or inserting a new memory card.

[SERIES] : Under this system, the file name will directly follow the last stored file name, regardless of any actions such as file deletion or formatting.

5. Press the menu button twice and the menu will disappear.



File name

INFORMATION

- The first stored folder name is 100SSCAM, and the first file name is S2500001.
- Whenever you store an image, the file number is increased by 1.
- The file numbers are named from S2500001 to S2509999 automatically, 9999 files will be stored in a folder.
- The folder number is assigned sequentially from 100 to 999 as follows :
100SSCAM → 101SSCAM → → 999SSCAM.
- The files used with the memory card conform to the DCF(Design rule for Camera File systems) format.

Auto power off

- This function switches the camera off after a set amount of time in order to prevent unnecessary battery drainage.

● Setting Power Off

1. In any mode with the exception of Voice Recording mode, press the MENU button.
2. Press the LEFT/ RIGHT button and select the [SETUP] menu tab.
3. Select the [PWR OFF] menu by pressing the UP/ DOWN button and press the RIGHT button.
4. Select a desired sub menu by pressing the UP/ DOWN button and press the OK button.
[CANCEL] : The power off function will not operate.
[1~10 MIN]: The power will turn off automatically if not used for the period of time specified.
5. Press the menu button twice and the menu will disappear.



INFORMATION

- Even if the batteries or AC adapter are removed and inserted again, the power off setting will be preserved.
- Note that the automatic power off function will not operate if the camera is in PC mode, slide show, playing back a voice recording or movie clip.

Language

- There is a choice of languages that can be displayed on the LCD monitor. Even if the batteries or AC adapter are removed and inserted again, the language setting will be preserved.

● Setting Language

1. In any mode with the exception of Voice Recording mode, press the MENU button.
2. Press the LEFT/ RIGHT button and select the [SETUP] menu tab.
3. Select the [LANGUAGE] menu by pressing the UP/ DOWN button and press the RIGHT button.
4. Select a desired sub menu by pressing the UP/ DOWN button and press the OK button.



LANGUAGE sub menu : English, Korean, French, Italian, German, Spanish, T.Chinese, S.Chinese, Thai

5. Press the menu button twice and the menu will disappear.

Formatting a memory card

- This is used for formatting the memory card. If you run [FORMAT] on the memory card, all images, including the protected images, will be deleted. Be sure to download important images to your PC before formatting the memory card.

● Formatting a Memory Card

1. In any mode other than Voice Recording mode, press the MENU button.
2. Press the LEFT/ RIGHT button and select the [SETUP] menu tab.
3. Select the [FORMAT] menu by pressing the UP/ DOWN button and press the RIGHT button.
4. Select a desired sub menu by pressing the UP/ DOWN button and press the OK button.



If [No] is selected : The memory card will not be formatted.

Press the menu button twice and the menu display will disappear.

If [Yes] is selected : A [PLEASE WAIT!] message appears and the memory card will be formatted. If you ran FORMAT in Play mode, a [NO IMAGE!] message will appear.

INFORMATION

- Be sure to run [FORMAT] on the following types of memory card.
 - A new memory card, or an unformatted memory card.
 - A memory card that has a file this camera can't recognize or one that has been taken from another camera.
- Always format the memory card using this camera. If you insert a memory card that has been formatted using other cameras, memory card readers, or PCs, you will get a [CARD ERROR!] message.

Setting up the Date/ Time/ Date type

- You can change the date and time that will be displayed on the captured images and set up the date type.

- Setting Date/Time & Selecting Date Format

1. In any mode with the exception of Voice Recording mode, press the MENU button.

2. Press the LEFT/ RIGHT button and select the [SETUP] menu tab.

3. Select the [DATE] menu by pressing the UP/ DOWN button and press the RIGHT button.

4. Use the UP, DOWN, LEFT, and RIGHT buttons to select the desired submenu value, and then press the OK button.

RIGHT button: Selects the year/month / day/hour / minute date format.

LEFT button: Moves the cursor to the [DATE] main menu if the cursor is at the first item of the date and time setup.

In all other cases, the cursor will be shifted to the left of its current position.

UP and DOWN buttons: Changes the setting value.

- Date type : [YY/MM/DD] / [MM/DD/YY] [DD/MM/YY]

5. Press the menu button twice and the menu will disappear.



Imprinting the recording date

- There is an option to include DATE/TIME on still images.

- Date Imprinting

1. In any mode with the exception of Voice Recording mode, press the MENU button.

2. Press the LEFT/ RIGHT button and select the [SETUP] menu tab.

3. Select the [IMPRINT] menu by pressing the UP/ DOWN button and press the RIGHT button.

4. Use the UP and DOWN buttons to select the desired date imprint type, and then press the OK button.

[OFF] : The DATE & TIME will not be imprinted on the image file.

[DATE] : Only the DATE will be imprinted on the image file.

[D&TIME] : The DATE & TIME will be imprinted on the image file.

5. Press the menu button twice and the menu will disappear.

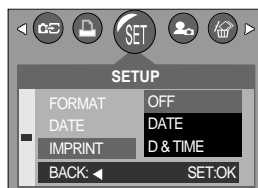

INFORMATION

- The Date & Time are imprinted at the bottom right side of the still image.
- The date will be imprinted as a DATE TYPE setting.
- TIME is imprinted in the following way : [Hour : Minute : Second] and hours are shown using the 24 hour clock.
- The imprint function is applied only to still images.

Beep

- If you set the operation sound to ON, various sounds will be activated for camera startup, when buttons are pressed, and if there is a card error, so that you can be aware of the camera operation status.

● Setting Operation Sounds

1. In any mode with the exception of Voice Recording mode, press the MENU button.
2. Press the LEFT/ RIGHT button and select the [SETUP] menu tab.
3. Select the [BEEP] menu by pressing the UP/ DOWN button and press the RIGHT button.
4. Select a desired sub menu by pressing the UP/ DOWN button and press the OK button.
[BEEP] sub menu : OFF/ON
5. Press the menu button twice and the menu will disappear.

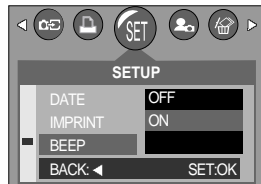

LCD brightness

- You can adjust the LCD brightness.

● Adjusting LCD Brightness

1. In any mode with the exception of Voice Recording mode, press the MENU button.
2. Press the LEFT/ RIGHT button and select the [SETUP] menu tab.
3. Select the [LCD] menu by pressing the UP/ DOWN button and press the RIGHT button.
4. Select a desired sub menu by pressing the UP/ DOWN button and press the OK button.
- [LCD] sub menu : DARK, NORMAL, BRIGHT
5. Press the menu button twice and the menu will disappear.



Selecting Video out type

- The Movie output signal from the camera can be NTSC or PAL. Your choice of output will be governed by the type of device (monitor or TV, etc.) to which the camera is connected. PAL mode can support only BDGHI.

● Setting the Video Out Type

1. In any mode other than Voice Recording mode, press the MENU button.
2. Press the LEFT/ RIGHT button and select the [SETUP] menu tab.
3. Select the [VIDEO] menu by pressing the UP/ DOWN button and press the RIGHT button.
4. Select a desired sub menu by pressing the UP/ DOWN button and press the OK button.
 - [VIDEO] sub menu : NTSC, PAL
5. Press the menu button twice and the menu will disappear.



● Connecting to an external monitor

In RECORDING/ PLAY mode, you can view the stored still images or movie clips by connecting the camera to an external monitor via the VIDEO cable. When the camera is connected to an external monitor, the LCD monitor will be turned off automatically.

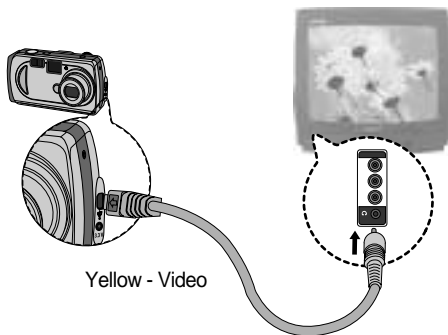

INFORMATION

- NTSC : U.S.A, Canada, Japan, South Korea, Taiwan, Mexico.
- PAL : Australia, Austria, Belgium, China, Denmark, Finland, Germany, U.K., Holland, Italy, Kuwait, Malaysia, New Zealand, Singapore, Spain, Sweden, Switzerland, Thailand, Norway.
- When using a TV as an external monitor, you will need to select the external or AV channel of the TV.
- There will be a digital noise on the external monitor, but it is not a malfunction.
- If the image is not in the centre of the screen, use the TV controls to centre it.
- When the camera is connected to an external monitor, the menu will be visible on the external monitor and the menu functions are the same as those indicated on the LCD monitor.

Quick view

- If you enable Quick View before capturing an image, you can view the image you just captured on the LCD monitor for the duration set in the [Q.VIEW] setup. Quick view is possible only with still images.

● Setting Quick View

1. In any mode with the exception of Voice Recording mode, press the MENU button.
2. Press the LEFT/ RIGHT button and select the [SETUP] menu tab.
3. Select the [Q.VIEW] menu by pressing the UP/ DOWN button and press the RIGHT button.
4. Select a desired sub menu by pressing the UP/ DOWN button and press the OK button.



[OFF] : The quick view function can't be activated.

[1 ~ 3 SEC] : The captured image is briefly displayed during the selected time.

5. Press the menu button twice and the menu will disappear.

Initialization(RESET ALL)

- All camera menu and function settings will be restored to their default values. However, values for DATE/TIME, LANGUAGE, and VIDEO OUT will not be changed.

● Initializing the Camera

1. In any mode with the exception of Voice Recording mode, press the MENU button.
2. Press the LEFT/ RIGHT button and select the [SETUP] menu tab.
3. Select the [RESET] menu by pressing the UP/ DOWN button and press the RIGHT button.
4. Select a desired sub menu by pressing the UP/ DOWN button and press the OK button.



If [NO] is selected : Settings will not be restored to their defaults.

If [YES] is selected : All settings will be restored to their defaults.

5. Press the menu button twice and the menu will disappear.

Latest

- The most recent changes made to the camera setting values since [LATEST] has been set to [YES] will be maintained. The changed setting values are maintained even after the camera is turned off and then back on.

- Saving Camera Functions

1. In any mode other than Voice Recording mode or MySET mode, press the MENU button.
2. Press the LEFT/ RIGHT button and select the [SETUP] menu tab.
3. Select the [LATEST] menu by pressing the UP/ DOWN button and press the RIGHT button.
4. Select a desired sub menu by pressing the UP/ DOWN button and press the OK button.



- If [NO] is selected : The changed camera functions will not be saved.
- If [YES] is selected : The changed camera functions will be saved.

5. Press the menu button twice and the menu will disappear.

- The menus to which the changed values are saved regardless of the Latest function are as follows : SIZE, QUALITY, PHOTO FRAME, START IMAGE, and all SETUP menus
- When the [LATEST] is [YES], the menus to which the changed values are always saved are as follows: FLASH, METERING, EXPOSURE COMPENSATION, SHARPNESS, EFFECT, and WHITE BALANCE.

Start image

- You can select the image that is first displayed on the LCD monitor whenever the camera is turned on.

- Setting a Startup Image

1. In any mode other than Voice Recording mode, press the MENU button.
2. Press the LEFT/ RIGHT button and select the [START IMAGE] menu tab.
3. Select the [IMAGE] menu by pressing the UP/ DOWN button and press the RIGHT button.



- If [OFF] is selected: The startup image will not be displayed.
- If [IMAGE 1, IMAGE 2] is selected: The Samsung brand logo will be displayed.
- If [IMAGE 3] is selected: The startup image you created in [RESIZE] will be displayed.

Important notes

Be sure to observe the following precautions!

- This unit contains precision electronic components. Do not use or store this unit in the following locations.
 - Areas exposed to severe changes in temperature and humidity.
 - Areas exposed to dust and dirt.
 - Areas exposed to direct sunlight or the inside of a vehicle in hot weather.
 - Environments where there is high magnetism or excessive vibration.
 - Areas with high explosives or highly flammable materials.

- Do not let the unit come into contact with dust, vinyl goods, or chemicals, such as insecticides, for an extended period of time.

- Sand can be particularly troublesome to cameras.
 - Do not let sand get inside the unit when using it on beaches, coastal dunes, or other areas where there is lots of sand.
 - Doing so may result in failure or may permanently render the unit unusable.

- Extremes in temperature may cause problems.
 - If the camera is transferred from a cold to a warm and humid environment, condensation can form on the delicate electronic circuitry. If this occurs, turn the camera off and wait for at least 1 hour until all moisture is dispersed. Moisture build up can also occur in the memory card. If this happens, turn off the camera and remove the memory card. Wait until the moisture has dispersed.

- Caution on Using the Lens
 - If the lens is subjected to direct sunlight, it could result in discoloration and deterioration of the image sensor.
 - Pay attention not to get fingerprints or foreign substances on the surface of the lens.

- If the digital camera is not used for a long period, an electric discharge can occur. It is a good idea to remove the batteries and the memory card if you do not intend using the camera for an extended period of time.

Important notes

- If the camera is exposed to an electronic interference, it will turn itself off to protect the memory card.

- Camera Maintenance
 - Use a soft brush (available from photo stores) to gently clean the lens and LCD assemblies. If this does not work, lens-cleaning paper with lens cleaning fluid can be used.
 - Clean the camera body with a soft cloth. Do not allow this camera to come into contact with solvent materials such as benzol, insecticide, thinners etc. This may damage the body shell of the camera and also affect its performance. Rough handling can damage the LCD monitor. Take care to avoid damage and keep the camera in its protective carry case at all times when not in use.

- Do not attempt to disassemble or modify the camera.

- Under certain conditions, static electricity can cause the flash unit to fire. This is not harmful to the camera and is not a malfunction.

- When images are uploaded or downloaded, the data transfer may be affected by static electricity. In this case, disconnect and re-connect the USB cable before trying the transfer again.

Warning indicator

- There are several warnings that may appear on the LCD display

Warning indicator	Causes	Remedy
CARD FULL !	<ul style="list-style-type: none">• There is insufficient memory capacity to take an image.	<ul style="list-style-type: none">• Insert a new CARD or delete stored images to free up some memory.
LOW LIGHT !	<ul style="list-style-type: none">• When taking pictures in dark places.	<ul style="list-style-type: none">• Use a tripod and take pictures in Flash Photography mode.
CARD LOCKED !	<ul style="list-style-type: none">• The memory card is locked	<ul style="list-style-type: none">• Slide the write protect switch to the top of the memory card.(p.18)
NO IMAGE !	<ul style="list-style-type: none">• There are no images stored on the internal memory or the CARD.	<ul style="list-style-type: none">• Take images.• Insert a memory card that is holding some images
CARD ERROR	<ul style="list-style-type: none">• Memory card error	<ul style="list-style-type: none">• Insert a new card or format the memory.
MEMORY ERROR!	<ul style="list-style-type: none">• Internal memory error	<ul style="list-style-type: none">• Format the memory with the memory card removed. (p.64)
A battery indicator blinks!	<ul style="list-style-type: none">• There is low battery capacity	<ul style="list-style-type: none">• Insert fresh batteries
Camera shake warning indicator!	<ul style="list-style-type: none">• The flash mode is set to flash off	<ul style="list-style-type: none">• Disengage the FLASH OFF mode (For ordinary shots)• Use a tripod (For taking shots in more unusual circumstances ; museum, art center)

Before contacting a service center

Please check the following

Symptom	Causes	Remedy
The camera doesn't switch on	<ul style="list-style-type: none"> - There is low battery capacity - An AC Power Adapter is not connected 	<ul style="list-style-type: none"> - Insert fresh batteries - Connect an AC Power Adapter
The camera power ceases whilst in use	<ul style="list-style-type: none"> - The batteries are exhausted - The Camera is turned off automatically. - The Adapter plug is not connected securely 	<ul style="list-style-type: none"> - Insert fresh batteries - Slide the power switch to reactivate camera - Remove and re-insert the plug
Batteries drain quickly	<ul style="list-style-type: none"> - The Camera is being used in low temperatures - Mixing old and new batteries or battery types 	<ul style="list-style-type: none"> - Keep the camera in warm conditions (i.e. inside a coat or jacket) and only remove it in order to take images - Insert fresh batteries (all of which should be of the same type)
Camera does not take images when pressing the Shutter button	<ul style="list-style-type: none"> - There is insufficient memory capacity - The memory card has not been formatted - The memory card is exhausted - The camera's power is off - The batteries are exhausted - The memory card is locked 	<ul style="list-style-type: none"> - After turning the camera off, insert a new memory card or delete unnecessary image files. - Format the memory card. - Insert a new memory card - Turn the camera power on - Insert fresh batteries - Slide the write protect switch to the top of the memory card
The images are unclear	<ul style="list-style-type: none"> - A picture was taken within 0.8 m from the subject without setting an appropriate macro mode. 	<ul style="list-style-type: none"> - If the shooting distance is less than 0.8 m from the subject, set MACRO mode.
The flash does not fire	<ul style="list-style-type: none"> - FLASH OFF mode has been selected. 	<ul style="list-style-type: none"> - Disengage FLASH OFF mode
Incorrect date and time is displayed	<ul style="list-style-type: none"> - The date and time have been set incorrectly. 	<ul style="list-style-type: none"> - Reset the date and time correctly. (p.65)

Before contacting a service center

Symptom	Causes	Remedy
The camera buttons do not operate	<ul style="list-style-type: none"> • Camera malfunction 	<ul style="list-style-type: none"> • Remove / re-insert batteries and switch camera on
A card error has occurred while the memory card is in the camera.	<ul style="list-style-type: none"> • Incorrect memory card format 	<ul style="list-style-type: none"> • Re-format the memory card (p.64)
Colour of image is different to the original scene	<ul style="list-style-type: none"> • White balance setting is incorrect. 	<ul style="list-style-type: none"> • Select appropriate White balance.
Images are too bright	<ul style="list-style-type: none"> • Exposure is excessive. 	<ul style="list-style-type: none"> • Reset exposure compensation.
The play back display is not very clear	<ul style="list-style-type: none"> • The lens or LCD monitor is smudged or dirty 	<ul style="list-style-type: none"> • Clean the lens or LCD
Date is not displayed on the LCD monitor in the PLAY mode	<ul style="list-style-type: none"> • Date imprint function is set to OFF 	<ul style="list-style-type: none"> • Switch the Date imprint function ON.
When using the PC's explorer, the [Removable Disk] file does not show	<ul style="list-style-type: none"> • Cable connection is incorrect. • The camera is off. • There are no batteries, the batteries are exhausted or the AC adapter is not connected. • The operating system is not Windows 98, 98SE, 2000, ME, XP/ Mac OS 9.1~10.2. Alternatively the PC does not support USB. • The USB driver is not installed. 	<ul style="list-style-type: none"> • Check the connection. • Turn the camera on. • Insert new batteries or check the adapter connection. • Install Windows 98, 98SE, 2000, ME, XP/ Mac OS 9.1~10.2 to PC that supports USB. • Install a [USB Storage Driver].
The images don't play back.	<ul style="list-style-type: none"> • Incorrect file name. (Violation of DCF format) 	<ul style="list-style-type: none"> • Do not change the image file name.

Specifications

Image Sensor	Type	1/3.2" CCD
	Effective Pixels	Approx. 2.10 Mega-pixel
	Total Pixels	Approx. 2.14 Mega-pixel
Lens	Focal Length	Lens f=5.0 ~ 10.0mm (35mm film equivalent: 38~76mm)
	F No.	F3.4 ~F4.3
	Digital Zoom	Still Image mode: 1.0X ~ 2.0X Play mode: 1.0X~ 5.0X (depends on Image size)
Viewfinder	Optical Viewfinder	Optical virtual image viewfinder
	LCD Monitor	1.5" color TFT LCD
Focusing	Type	Auto focus
	Range	Normal: 0.80m~infinity Macro - wide: 0.15m ~ 0.8m, tele : 0.6m ~ 0.8m
Shutter	Type	Mechanical and Electrical shutter
	Speed	5 - 1/2000 sec.(Auto, 1 ~ 5sec.in Night Scene Mode)
Exposure	Control	Programmed AE Metering(Multi, Spot)
	Compensation	±2EV (0.5EV steps)
	ISO Equivalent	Auto
Flash	Modes	Auto, Auto & Red - eye reduction, Slow sync, Fill-in flash, Flash Off
	Range	Normal - wide: 0.8m ~ 3m, tele : 0.8m ~ 2.5m Macro - wide: 0.15m ~ 0.8m, tele : 0.6m ~ 0.8m
	Recharging Time	Approx. 8 sec.
Sharpness		Soft, Normal, Vivid
Effect		B&W, Normal, Sepia
White Balance		Auto, Daylight, Cloudy, Sunset, Fluorescent, Tungsten, Custom
Photo Frame		9 Frames
Voice Recording		Voice Recording(max. 1 hour) Voice Memo in Still Image (max. 10.sec)
Date Imprinting		Date & Time, Date, Off (User selectable)
Shooting	Still Image	Modes: Auto, Night Scene, Photoframe, Myset Continuous: Single, Continuous, AEB. Self-timer: 10 sec., 2 sec., Double Self Timer (10 / 2sec.)
	Movie Clip	With audio but no speaker in Camera (recording time: memory capacity dependent) 30fps, 15fps for 320x240(QVGA), Continuous Movie Clip
Storage	Media	Internal memory: 6.0MB flash memory External memory: SD card /MMC(up to 256MB guaranteed)

Specifications

Storage	File Format	Still Image: JPEG(DCF), DPOF 1.1, EXIF 2.2 Movie Clip: MOV (MPEG4) Audio: WAV
	Image Size	1600: 1600x1200 pixels, 1024: 1024x768 pixels 800: 800x600 pixels, 640: 640x480 pixels
	Capacity (6MB)	Approx. : 1600 : Super fine (6) / Fine (10) / Normal (16) 1024: Super fine (15) / Fine (26) / Normal (40) 800: Super fine (25) / Fine (43) / Normal (64) 640: Super fine (40) / Fine (64) / Normal (92) * These figures are measured under Samsung's standard conditions and may vary depending on shooting conditions and camera settings.
Image Play	Type	Single image, Thumbnails, Slide show, Movie Clip
	Editing	Trimming, Rotating, Resizing
Interface		Digital output connector: USB 1.1 Video output: NTSC, PAL (User selectable) DC power input connector : 3.3V
Power Source		Primary Battery : 2x AA alkaline, 1x CR-V3(Lithium) Rechargeable Battery : 2x Ni-MH, 1x I-Pack (SBP-1303) Adapter : SAC-32 (DC 3.3V, 2.0A) * Included power source may vary depending on sales region.
Dimensions (WxHxD)		106.5 x 56.5 x 39.5 mm
Weight		143g (without batteries and card)
Operating Temperature		0 ~ 40 °C
Operating Humidity		5 ~ 85%
Software	Camera	Storage Driver (Windows98/98SE/2000/ME/XP, Mac OS 9.1 ~10.2)
	DriverApplication	Digimax Viewer 2.1, Arcsoft PhotoImpression, Quicktime Player 6.3
Special Features		Mpeg4 Movie Clip with Continuous Movie Clip (30fps), 9 Photoframes

※ Specifications are subject to change without prior notice.

Software Notes

Please ensure that you read the instruction manual carefully before use.

- The attached software is a camera driver and image editing software tool for Windows.
- Under no circumstances should all or part of either the software or the user manual be reproduced.
- Copyrights for software are licensed only for use with a camera.
- In the unlikely event of a manufacturing fault, we will repair or exchange your camera. We cannot, however, be held responsible in any way for damage caused by inappropriate use.
- Using a Hand-made PC or a PC and OS that has not been guaranteed by the manufacturer is not covered by the Samsung warranty.
- Before reading this manual, you should have a basic knowledge of computers and O/S (Operating Systems).

System Requirements

For Windows	For Macintosh
PC with processor better than MMX Pentium 233MHz (XP : Pentium II 300MHz)	Power Mac G3 or later
Windows 98/98SE/2000/ME/XP	Mac OS 9.1 ~ 10.2
Minimum 32MB RAM (XP : 128MB) 140MB of available hard-disk space	Minimum 64MB RAM 110MB of available hard-disk space
USB port	USB port
CD-ROM drive	CD-ROM drive
800x600 pixels, 16-bit colour display compatible monitor (24-bit color display recommended)	QuickTime 4.0 or later for Movie Clip

About the software

After inserting the CD-ROM provided with this camera into the CD-ROM drive, the following window should automatically run.



Before connecting the camera to the PC, you should first install the camera driver.

- **Camera driver** : This enables images to transfer between the camera and PC.
This camera uses the USB Storage Driver as the camera driver. You can use the camera as a USB card reader. After installing the driver and connecting this camera to the PC, you can find [Removable Disk] in [Windows Explorer] or [My computer]. A USB Storage Driver is provided only for Windows. A USB Driver for MAC is not included with the Application CD. But you can use the camera with Mac OS 9.1 ~ 10.2.
- **Digimax Viewer** : This is a program for viewing stored images.
You can see the stored images in the memory directly on a PC monitor. You can also copy, move or delete the images and enlarge/downscale the image sizes with Digimax Viewer. This software is only compatible with Windows.
- **PhotoImpression** : Image editing program.
You can edit or store still images that you download from the camera. This software is only compatible with Windows.

INFORMATION

- Be sure to check the system requirements (page 77) before installing the driver.
- You should allow 5~10 seconds for running the automatic setup program according to the capability of the computer. If the frame does not show, run the [Windows Explorer] and select [Samsung.exe] in the CD-ROM Drive root directory.

Setting up the application software

To use this camera with a PC, install the application software first.

After this has been done, the stored images in the camera can be moved to the PC and can be edited by an image editing program.

INFORMATION

- Close other programs before installing the application software.
- Before installing the application software, disconnect the USB connection.

You can visit the Samsung web-site through the internet.

<http://www.samsungcamera.com> : English

<http://www.samsungcamera.co.kr> : Korean

1. Click the [Install] menu in the Autorun frame.

The Digimax 250 camera driver is installed automatically.

[Click !]



2. Installation is complete.

Click the [Finish] button.

[Click !]



3. Click [Next >] to begin installing QuickTime.

[Click !]



4. A Welcome window will appear.

Click [Next >] to proceed to the next screen.

[Click !]

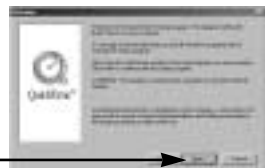

Setting up the application software

5. The 'Software License Agreement' window will open, asking you to agree to the licensing. Use the button on the bottom left to select the language of your choice, and then click [Agree] to accept the license agreement. The installation will proceed to the next stage. If you do not agree to the license agreement, click [Disagree]. The installation will be cancelled.



If the language of your choice is not listed, please select [English].

6. A window will open, asking you to select a destination folder for where the files will be copied to. Click [Next >]. To copy the files to another folder, click [Browse..] Select the folder you want to copy the files to.



[Click !]

7. The Choose Installation Type window will open.

Click [Next >].

[Minimum] : Installs required files only.

[Recommended] : Installs required files and the most commonly used optional files.

[Custom] : Allows you to install only the components you choose.



[Click !]

8. A window will open, asking you to choose a folder to which program icons will be added. Click [Next >]. If you want to add the program icons to a different folder, choose another folder, and then click [Next >].



[Click !]

9. The Enter Registration window appears.

Enter your name and organization in the respective fields, and then click [Next >].

You do not have to enter a registration number.



[Click !]

Setting up the application software

※ The QuickTime program folder will appear. Click on the Close button to close the folder.

10. The QuickTime Settings - Introduction window appears. Click [Next >].

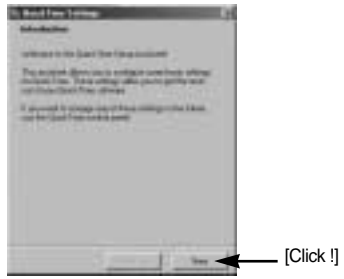

11. Set the transfer rate for downloading content from the Internet, and then click [Next >].

12. Set up your browser for QuickTime plug-in. Click [Next >].

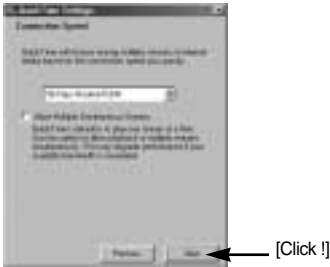

13. Specify the file types you want to associate with QuickTime. Click [Finish].

14. Installation is complete. Click [Close].

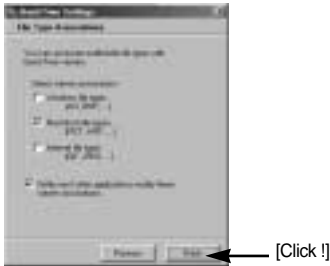

Setting up the application software

* The QuickTime Player will launch, the readme file will open, and the Step 15 window will open. Click on the Close 1 and Close 2 buttons to exit the program.



[Close 1 button]



[Close 2 button]

15. A window will appear which enables you to choose where you want to install the program too. Click [Install]. For information on application software, please refer to page 78.



[Click !]

※ If you select [Cancel], the application program installation will be cancelled.

16. The [Digimax Viewer 2.1] installation window will be displayed as shown. Click the [Next] button.



[Click !]

INFORMATION

- If you select [Cancel] at step 16, a window for installing PhotoImpression will be displayed.

17. The Software License Agreement window will be displayed. If you agree to this, click [Yes], the window will then move to the next step. If you disagree, click [No] and the installation program will be cancelled.

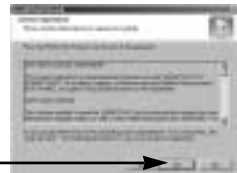

[Click !]

Setting up the application software

18. A destination selection window will open. Click [Next >].
To copy to the files another folder, click [Browse (R)..] and choose the folder you want.

[Click!]



19. A window will open, asking you to choose a folder to which program icons will be added. Click [Next >].
If you want to add the program icons to a different folder, choose another folder, and then click [Next >].

[Click!]



20. Digimax Viewer installation is successfully completed.
Click the [Finish] button to install PhotoImpression. The system will not reboot even the [Yes, I want to restart the computer now] option is selected.

* Depends on the system, screen for the step 20 may not display.

[Click!]



21. Digimax Viewer Installation is completed.
The PhotoImpression installation window will be displayed as shown.
Click the [OK] button.

[Click!]

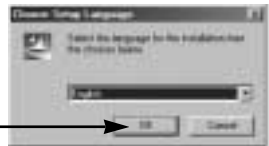

INFORMATION

- If you click [Cancel] in Step 21, the PhotoImpression installation will be cancelled and the Restart Computer window will appear.

22. A Welcome window will be displayed.
Click the [Next >] button.

[Click!]



Setting up the application software

23. The Software License Agreement window will be displayed. If you agree to this, click [Yes], the window will then move to the next step. If you disagree, click [No] and the installation program will be cancelled.



[Click!]

24. A destination selection window will open. Click [Next >]. To copy to the files to another folder, click [Browse...] and choose the folder you want.



[Click!]

25. The [Select Components] window will appear. Click [Next >] button.



[Click!]

26. A window will open, asking you to choose a folder to which program icons will be added. Click [Next >] button. If you want to add the program icons to a different folder, choose another folder, and then click [Next >] button.



[Click!]

27. Installation is complete. Click the [Finish] button.



[Click!]

Setting up the application software

28. To apply the changes, you have made, you must restart the computer. Select [Yes, I want to restart my computer now], and then click [OK].



[Click!]

* Depends on the system, following screen may display in the step 27. Click the [Finish] button to restart the system

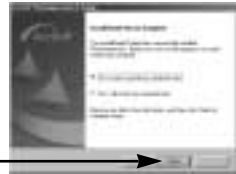

[Click!]

29. After restarting the computer, connect the PC to the camera with the USB cable.

30. Turn the camera power on. [Found New Hardware Wizard] will open and the computer will recognize the camera.



※ If you have ever installed an image viewer program or your OS is Windows XP, an image viewer program will open.

If the image viewer program opens, the camera driver was setup successfully.

31. If you can see [Removable Disk] under [My computer], the camera driver installation was successful. Now you can transfer image files from the camera to PC via the USB cable.



Setting up the application software

INFORMATION

- If you have installed the camera driver, [Found New Hardware Wizard] may not open.
- After the [Found New Hardware Wizard] window opens, a window asking you to select a driver file may appear. In this case, specify the C:\WINDOWS\INF folder (for Windows 98 and 98 SE). If you can't find the [INF] folder, check the [Show all files] button in [Window's Explorer → View → Folder option → View].
- When connecting the camera to your PC, it is recommended that you use an AC power adapter.
- Before connecting the camera to the PC, you should first install the camera driver.
- After installing the camera driver, you have to restart your PC.
- If you connect the camera to the PC before installing the camera driver, the [Found New Hardware Wizard] will open. In this case, cancel the [Found New Hardware Wizard] and disconnect the camera. Install the camera driver and connect the camera to the PC again.(p.79)
- Should the computer not find the camera driver after installation, please try one or more of the following measures.
 1. Delete the camera driver (p.90), and re-install the driver.
 2. Refer to FAQ (p.97~98) to check for a possible solution to the problem.
 3. If your PC's central processing unit is VIA chip (This is shown in the USB Host Controller), download the patch file from the Samsung Camera web page. (<http://www.samsungcamera.com>)

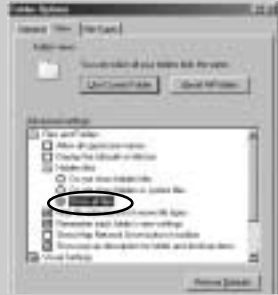

Starting PC Mode

- If you insert the USB cable into the USB connection terminal, the camera mode will change to the PC mode automatically.
- In this mode, you can download stored images to your PC through the USB cable.
- The LCD monitor is always turned off in PC mode.
- The auto focus lamp will blink when the files are transferring via the USB connection.

■ Connecting the camera to PC

1. Turn the PC power on.
2. Turn the camera power on.
3. Connect the PC and the camera via the USB cable.
 - Connect the small end of the USB cable to the USB port on the camera.
 - Connect the large end of the USB cable to the USB port on the computer.
 - Make sure the connectors are fully inserted.

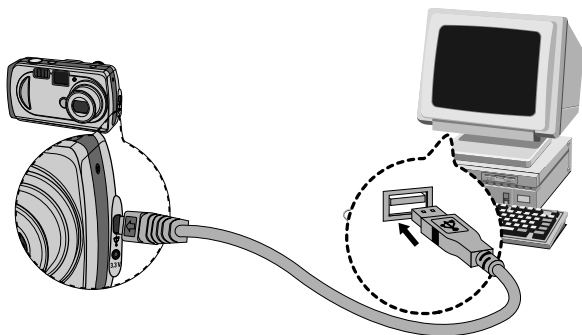

■ Disconnecting the camera and PC

Refer to the following page.

- WIN 98SE : p.92
- WIN 2000/ ME/ XP : p.92~93

INFORMATION

- The camera driver must be installed before using PC mode. For driver installation instructions, please refer to p.79.
- To save battery power, it is recommended that you use an AC adapter (Optional) when connecting the camera to a computer.

Starting PC Mode

■ Downloading stored images

You can download the still images stored on the camera to your PC's hard disk and print them or use a photo editing software to edit them.

1. Connect the camera to your PC with the USB cable.

2. On your computer's desktop display, select [My computer] and double click [Removable Disk → DCIM → 100SSCAM].

The image files will then be displayed.



3. Select an image and press the right mouse button.



4. A pop-up menu will open.

Click [Cut] or [Copy] menu.

- [Cut] : cuts a selected file.
- [Copy] : copies files.



5. Select the folder you want to paste the file to.

Starting PC Mode

6. Press the right mouse button and a pop-up menu will open. Click [Paste].



7. An image file will be transferred from the camera to your PC.



- You can view the pictures on the memory card if it is inserted into the camera.
- If the memory card is not inserted, the pictures stored in the internal memory will appear.
- By using [Digimax Viewer], you can see the stored images in the memory directly on the PC monitor and you can copy or move the image files.

Removing the USB Driver for Windows 98SE

■ To remove the USB driver, refer to the process shown below.

1. Trace [Start → Settings] and click [Control Panel].



2. Double-click [Add/Remove programs].



3. The [Add/Remove Programs Properties] window will open. Click [Samsung Digimax 250] and click the [Add/Remove] button.

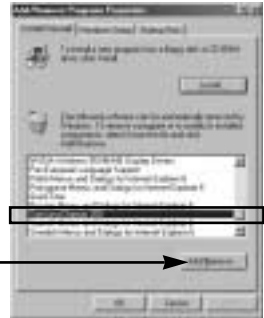

4. A window will open. Click the [OK] button and the camera driver will be removed.



5. Uninstallation is complete.

Click the [Finish] button and the window will disappear.



Removable Disk

■ To use this camera as a Removable Disk, install (p.79) the USB Driver.

1. Before turning the camera power on, connect the camera to the PC with the USB cable.
2. Click [Removable Disk] under [My computer] or [Windows Explorer].
3. Image files stored in the Removable Disk (DCIM →100SSCAM) can be transferred to the PC.

INFORMATION

Important information whilst using the Removable Disk

- The [Removable Disk] indicator will not show when the camera power is off or the USB cable is removed.
- We recommend that you should copy the images to the PC to view them. Opening images directly from the removable disk may be subject to unexpected disconnection.
- When uploading images from the PC to the camera, ensure that the uploaded file names are not the same as those already stored on the memory.
- When you upload a file that is not taken by this camera to Removable Disk, the [FILE ERROR!] message will be displayed on the LCD monitor in the PLAY mode, and nothing is displayed in THUMBNAIL mode.
- The auto focus lamp will blink, when a file is transferred (copy or deletion) between the PC and the camera. Do not remove the USB cable until the lamp stops blinking. To remove the USB cable in Windows 2000/ME/XP, use the [Unplug or Eject Hardware] icon on the task bar.

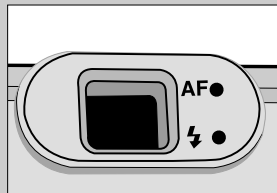

Removing the removable disk

■ Windows 98SE

1. Check whether the camera and PC are transferring a file. If the auto focus lamp blinks, you have to wait until the lamp illuminates.
2. Unplug the USB cable.

■ Windows 2000/ME/XP

1. Check whether the camera and PC are transferring a file. If the auto focus lamp blinks, you have to wait until the lamp illuminates.

2. Double-click the [Unplug or Eject Hardware] icon on the task bar.



[Double-click!]

3. The [Unplug or Eject Hardware] window will open. Select the [USB Mass Storage Device] and click the [Stop] button.



[Click!]

4. The [Stop a Hardware device] window will open. Select the [USB Mass Storage Device] and click the [OK] button.

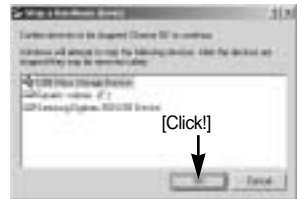

[Click!]

5. A [Safe to Remove Hardware] window will open. Click the [OK] button.



[Click!]

Removing the removable disk

6. A [Unplug or Eject Hardware] window will open.
Click the [Close] button and the removable disk will be removed safely.



7. Unplug the USB cable.

[Click!]

Setting up the USB Driver for MAC

1. A USB Driver for MAC is not included with the software CD as MAC OS supports the camera driver.
2. Check the MAC OS. You can check the MAC OS version during MAC OS start-up.
This camera is compatible with MAC OS 9.1 ~ 10.2.
3. Connect the camera to the Macintosh and turn the camera power on.
4. A new icon will be displayed on the desktop after connecting the camera to the MAC.

Using the USB Driver for MAC

1. Double click a new icon on the desktop and the folder in the memory will be displayed.
2. Select an image file and copy or move it to MAC.

INFORMATION

- For Mac OS 10.0 or later: First complete uploading from computer to camera and then remove the removable disk with the Extract command

Using Photolmpression

With Photolmpression, you can edit or store still images that you downloaded from the camera. This software is only available in Windows version.





To start the program, click [Start → Programs → ArcSoft Photolmpression → Photolmpression].

The following screen will appear.













You can use Photolmpression to perform the following tasks.

■ Command Button

Button	Description
	Imports a picture from an album, a source folder, or the camera/scanner, or captures screen shots of what is being viewed on the current monitor.
	Selects Cut, Resize, Edit Image, Insert Text, Enhance Picture, Insert Effects, or Layer.
	Performs Insert Frame, Insert Borders, Insert Calendar, Insert Greeting Cards, Insert Template, or Connect with Other Software.
	Saves the edited picture, and sends an e-mail or uses it as the background image.
	Outputs the edited picture according to your preferences.

Using Photolmpression

■ Tool Bar

Button	Description	Button	Description
	Resize Layer		Rotate Layer
	Flip Layer Horizontally		Rotate All Layers
	Undo		Redo
	Copy		Paste
	Delete Layer		Close Picture

INFORMATION

- For detailed instructions on how to use Photolmpression, please refer to the program's Help.

Digimax Viewer 2.1

This software is only compatible with Windows.



1. To open Digimax Viewer, click the [Start → Programs → Samsung → Digimax Viewer 2.1 → Digimax Viewer 2.1] and Digimax Viewer 2.1 will then open.

2. If the [Auto Launch] option is selected, this program will be executed automatically with recognizing the camera.



3. You can easily use the Digimax viewer 2.1 program as it offers a FILE menu and TOOL bar. And, you can use the pop up menu. Click an image and press the right mouse button.

Digimax Viewer functions are listed below.

- Basic functions : Copy, Move, Delete, Rotate, Rename, changing file type, Resize, Property.
- Advanced functions : Print, Slide show, Export, Sending e-mail, On-line print, Web album etc.

INFORMATION

- Before deleting images from the camera, you should protect or download images to your computer that you wish to keep.
- Refer to the [Help] menu in Digimax viewer 2.1 for further information.

FAQ

Please check the following if the USB connection malfunctions.

- [Case 1] The camera power is off.
→ Turn the camera power on. We recommend using an AC power adapter in PC mode.
- [Case 2] USB Driver is not installed correctly.
→ Install the USB Driver correctly. Refer to page 79.
- [Case 3] The USB cable is not connected or you are using a cable with an incorrect specification.
→ Use a USB cable with the correct specification.
- [Case 4] The camera is not recognized by your PC.
Sometimes, the camera may appear under [Unknown Devices] in Device Manager.
→ Install the camera driver correctly.
Turn off the camera, remove the USB cable, plug in the USB cable again, and then turn on the camera.
- [Case 5] There is an unexpected error during file transfer
→ Turn the camera power off and on again. Transfer the file again.
- [Case 6] How do I know my computer supports a USB Interface?
→ Check the USB port in your computer or keyboard.
→ Check the OS version. A USB Interface is available in Windows 98, 98SE, 2000, ME .XP.
→ Check [Universal serial bus controller] in Device Manager. Do the following to check [Universal serial bus controller].
Win 98/ME : Trace [Start → Setting → Controller → System → Device Manager → Universal serial bus controller]
Win 2000 : Trace [Start → Setting → Controller → System → Hardware → Device Manager → Universal serial bus controller].

Win XP : Trace [Start → Control Panel → Performance and Maintenance → System → Hardware Device Manager → Universal Serial Bus controller].

There must be USB Host Controller and USB root hub under [Universal serial bus controller].

In addition, double-click on the USB Universal Host Controller and the USB Root Hub to check if the Device Status states "This device is working properly". If the Device Status says the device is "not working properly", click the "Driver" tab and then click [Update Driver] or [Reinstall Driver].

- When all the conditions mentioned above are met, the computer can support the USB interface.

[Case 7]

When using the USB hub.

- There may be a problem in connecting the camera to the PC through the USB hub if the PC and the hub are not compatible. Wherever possible, connect the camera to the PC directly.

[Case 8]

Are other USB cables connected to the PC?

- The camera may malfunction when it is connected to the PC at the same time as another USB cable. In this case, disconnect the other USB cable, and connect only one USB cable to the camera.

[Case 9]

When I open the Device Manager (by clicking Start → (Settings) → Control Panel → (Performance and Maintenance) → System → (Hardware) → Device Manager), there are 「Unknown Devices」 or 「Other Devices」 entries with a yellow question mark(?) beside them or devices with an exclamation mark(!) beside them.

- Right-click on the entry with the question(?) or exclamation (!) mark and select "Remove". Restart the PC and connect the camera the again. For Windows 98 PC, remove the camera driver also, restart the PC, and then reinstall the camera driver.
- Double-click on the entry with the question(?) or exclamation(!) mark, click the "Driver" tab, and click [Update Driver] or [Reinstall Driver]. If a message appears asking you to specify the location where the appropriate driver for the device is, specify the "C:/Windows/inf" or "C:/Windows/inf/other" folder (where C: is the drive letter of the hard disk where the operating system is installed).

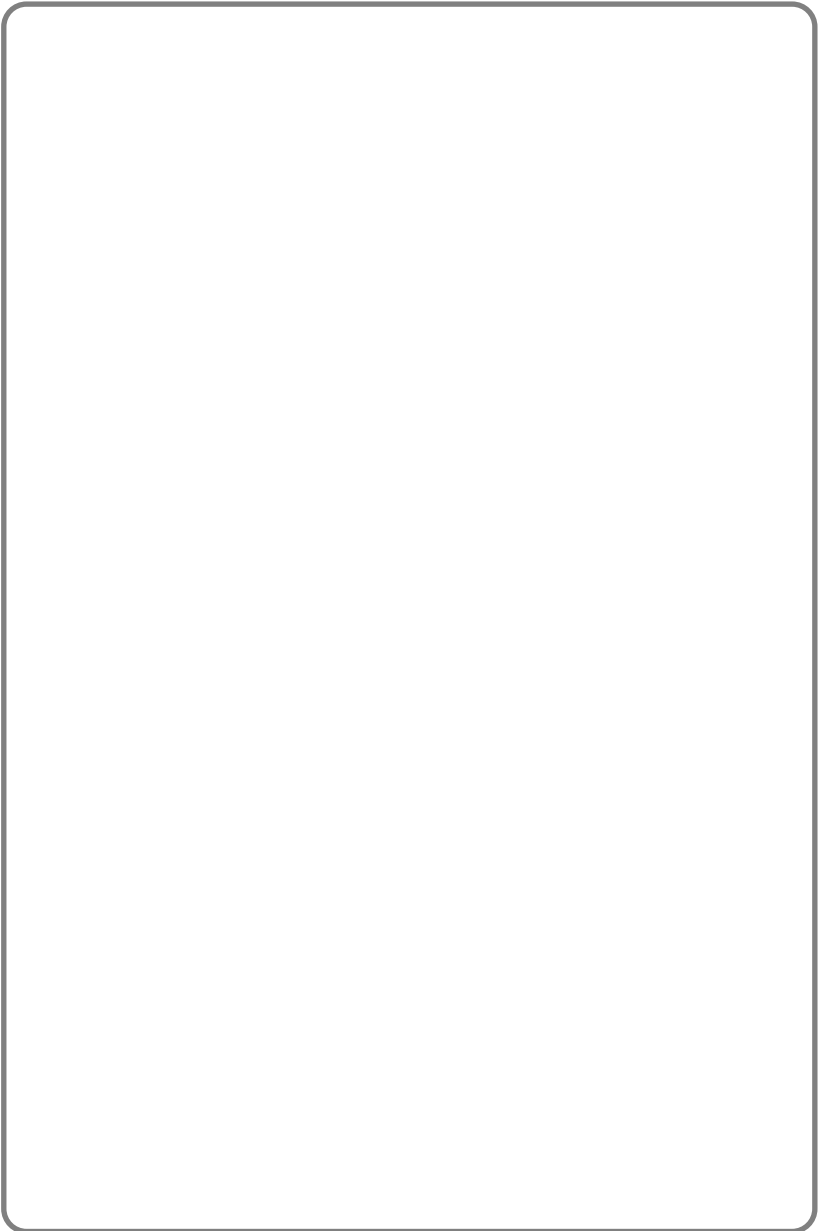

SAMSUNG

SAMSUNG TECHWIN CO., LTD.
OPTICS & DIGITAL IMAGING DIVISION
145-3, SANGDAEWON 1-DONG, JUNGWON-
GU, SUNGNAM-CITY, KYUNGKI-DO, KOREA
462-121
TEL : (82) 31-740-8086, 8088, 8090, 8092, 8099
FAX : (82) 31-740-8398, 8111

SAMSUNG OPTO-ELECTRONICS AMERICA, INC.
HEADQUARTERS
40 SEAVIEW DRIVE, SECAUCUS, NJ07094, U.S.A.
TEL : (1) 201-902-0347
FAX : (1) 201-902-9342

WESTERN REGIONAL OFFICE
18600 BROADWICK ST.,
RANCHO DOMINGUEZ, CA 90220, U.S.A.
TEL : (1) 310-537-7000
FAX : (1) 310-537-1566

SAMSUNG OPTO-ELECTRONICS UK LIMITED
SAMSUNG HOUSE
1000 HILLSWOOD DRIVE
HILLSWOOD BUSINESS PARK
CHERTSEY KT16 OPS U.K.
TEL : +44 (0) 1932 455300
FAX : +44 (0) 1932 455325

SAMSUNG OPTO-ELECTRONICS GMBH
AM KRONBERGER HANG 6
D-65824 SCHWALBACH/TS., GERMANY
TEL : (49) 6196 66 53 03
FAX : (49) 6196 66 53 66

SAMSUNG FRANCE S.A.S.
BP 51 TOUR MAINE MONTPARNASSE
33, AV. DU MAINE
75755, PARIS CEDEX 15, FRANCE
HOTLINE PHOTO NUMÉRIQUE :
00 800 22 26 37 27 (Numéro Vert-Appel Gratuit)
TEL : (33) 1-4279-2282/5
FAX : (33) 1-4320-4510

SAMSUNG TECHWIN MOSCOW OFFICE
KORP. 14 37-A LENNINGRADSKY PR-KT
MOSCOW, 125167, RUSSIA
TEL : (7) 095-258-9296, 9298, 9299
FAX : (7) 095-258-9297

TIANJIN SAMSUNG OPTO-ELECTRONICS CO.,LTD.
7 PINGCHANG ROAD NANKAI DIST., TIANJIN
P.R. CHINA
POST CODE:300190
TEL : (86) 22-2761-8867
FAX : (86) 22-2761-8864

* Internet address - <http://www.samsungcamera.com/>



The CE Mark is a Directive conformity
mark of the European Community (EC)



6806-1835